

InstaShade
PARASOLS

TIMELESS SHADE

CRAFTED FOR COMMERCIAL & RESIDENTIAL SPACES



INSTASHADE.CO.UK

InstaShade

PARASOLS

OUTDOOR SHADE EXPERTS

A family-run business rooted in over
20 years of industry expertise

01925 859 960 | info@instashade.co.uk | www.instashade.co.uk



Welcome

Revitalise your outdoor space with sleek and intelligent outdoor solutions crafted by Instashade. We're dedicated to delivering exceptional parasols that seamlessly blend style and practicality. Explore our exquisite range of parasols, meticulously designed to elevate your outdoor experience with both elegance and functionality.

As a family-run business established in 2006, our expertise in the industry and strong client relationships make us a trusted choice for your outdoor needs, whether you're a large corporate organisation or a homeowner with an eye for exterior design.

We pride ourselves on excellent customer service, and supply only the finest, most innovative parasols on the market. All of our products include a minimum two-year warranty, to give you confidence in the quality of our parasols.

If you need guidance in selecting the perfect parasol for your needs, our team is here to assist you every step of the way. Your satisfaction is our priority, and we look forward to helping you transform your outdoor space with style and functionality.

Our Team

Tel: 01925 859 960

E-mail: info@instashade.co.uk

Web: www.instashade.co.uk



Daniel
Director



Sara
Director



Amanda
Sales Manager

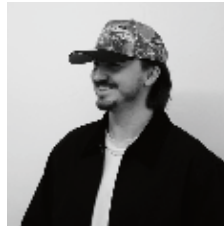

Joe
Head of Marketing



Jamie H
Production Manager



Jason
Print & Production
Technician



Leroy
Warehouse Manager



Krzysztof
Installation Manager /
Warehouse Operative



Nadia
Head of Business
Development



Scott
Sales Executive



Laura
Sales Executive



Charles
Marketing Executive

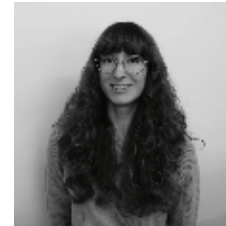

Poppy
Print Technician
Apprentice

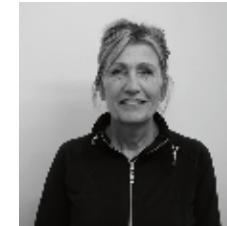

Jane
Seamstress



Jamie M
Warehouse Operative



Jodie
Installation Assistant /
Warehouse Operative

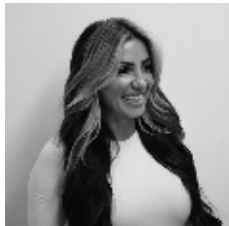

Joanne
Bookkeeper



Ben
Sales Executive



Andreina
Sales Executive



Leanne
Sales Support Assistant



Bill
Print Technician
Apprentice



Alistair
Warehouse Operative

Contents

01. Products	6	03. Bases & Installation	66
Aurora Cantilever Parasol	7	Free-Standing bases	67
Eclipse Cantilever Parasol	13	Installed Bases	68
Nova Centre Post Parasol	19	Our Installation Service	69
Nova With Heat & Light	23	Accessories	71
Vista Wall-Mounted Parasol	29		
Greenwich Centre Post Parasol	33		
Monterey Centre Post Parasol	37		
Café Series Centre Post Parasol	41		
Oakwood Deckchair	45		
02. Bespoke	48		
Custom Printing	49		
Valance Options	55		
Trims	57		
Our Fabrics	59		
Frame Options	63		

01. Products



Aurora

Cantilever Parasol

Introducing an elegant parasol, meticulously designed for effortless usability, perfect for homes and boutique hospitality.

Sizes Available

2.5m Square (Aluminium frame only), 2.8m Square, 3.5m Octagonal

Standard Colours

A large range of non-standard colours are available (see page 61) with an additional charge of £149.00 and increased production time.



Black

Cadet
Grey

Natural

Pistachio

Slate

Smoked
Tweed

Standard Frames



Aluminium

Wood Finish
2.8m Sq & 3.5m
Oct Only



3 FRAME
years WARRANTY



5 FADE
years WARRANTY



50 WIND
km/h RATING



801 UV
STANDARD



Aurora - 3.5m Octagonal · Natural · Aluminium

Aurora Cantilever Parasol

Dimensions

2.5m Square

2.8m Square

3.5m Oct

Measured from point to point. All measurements are rounded and are subject to change. Wind damage is not covered by the warranty.



Closed Parasol

a. Mast height (cm)	280	282	282
b. Distance from arms to ground (cm)	96	76	100
Weight of parasol when folded (kg)	26	27	27

Open Parasol

c. Height to canopy hub (cm)	198	210	200
d. Total height to top of canopy (cm)	254	274	264
e. Height to edge of canopy (cm)	189	215	210
f. Distance back of mast to edge of canopy (mm)	250	310	360
Canopy Shade Area	6.25m ²	7.8m ²	8.6m ²

Packaging Dimensions

Dimensions of cardboard packaging (cm)	297 x 51 x 31	297 x 51 x 31	297 x 51 x 31
Weight of boxed umbrella with spigot (kg)	60	60	60

Wind Rating Guide

Install Wind Rating (km/h)	50	50	50
Free-standing base rating (km/h)	30	30	30

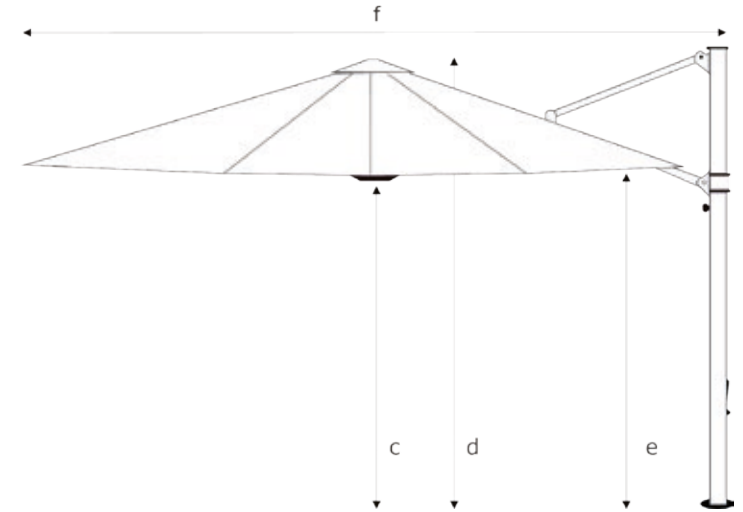
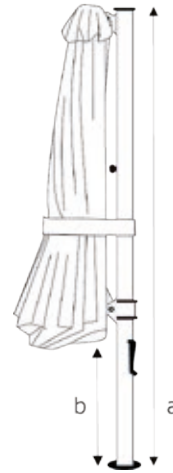

Bi-directional winder handle



Infinity tilt system



Easy glide slider car



Strengthened rib profile

Parasol Size	Frame	Canopy	Price
2.5m Square	Aluminium	Olefin	£1,579.00
2.8m Square	Aluminium	Olefin	£1,599.00
3.5m Octagonal	Aluminium	Olefin	£1,629.00

Accessories	Price
Protective Cover, 900D Black	£129.00
Protective Cover, Premium Acrylic	£169.00
Stabiliser Bars	£69.00
20cm Barrel Extension	£179.00
30cm Barrel Extension	£199.00
Slimline Re-Chargeable Clip On LED Lights	£59.00

Bases	Price
Base Plate in Black or Grey	£89.00
Stainless Steel Base Plate Upgrade	£219.00
In-Ground Base	£89.00
Cross base with Pavers	£339.00
Wheeled Free-Standing Base	£779.00
Timber Decking Installation Kit	£25.00
Concrete Installation Kit	£49.00

Non-standard frames have an additional £300.00 charge and a 12-15 week lead time. Wood Effect frames have an additional £269.00 charge.





“The best thing about this Instashade Parasol is that we can have protection over the seating area and then swing it around so that the family can gather around the table and we are still protected from the sun.”

- Ben Fogle



Eclipse

Cantilever Parasol

The Eclipse parasol is designed for longevity and durability. It is perfectly suited for both residential and commercial use.

Sizes Available

3m Square, 3.5m square, 4m Octagonal, 3m x 4m Rectangular

Standard Colours

A large range of non-standard colours are available (see page 61) with an additional charge of £149.00 and increased production time.

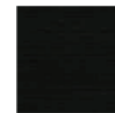

Black



Cadet
Grey

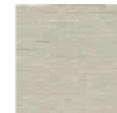

Natural



Pistachio



Slate

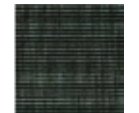

Smoked
Tweed

Standard Frames



Aluminium



5 FRAME
years WARRANTY



10 FADE
years WARRANTY



65 WIND
km/h RATING



801 UV
STANDARD

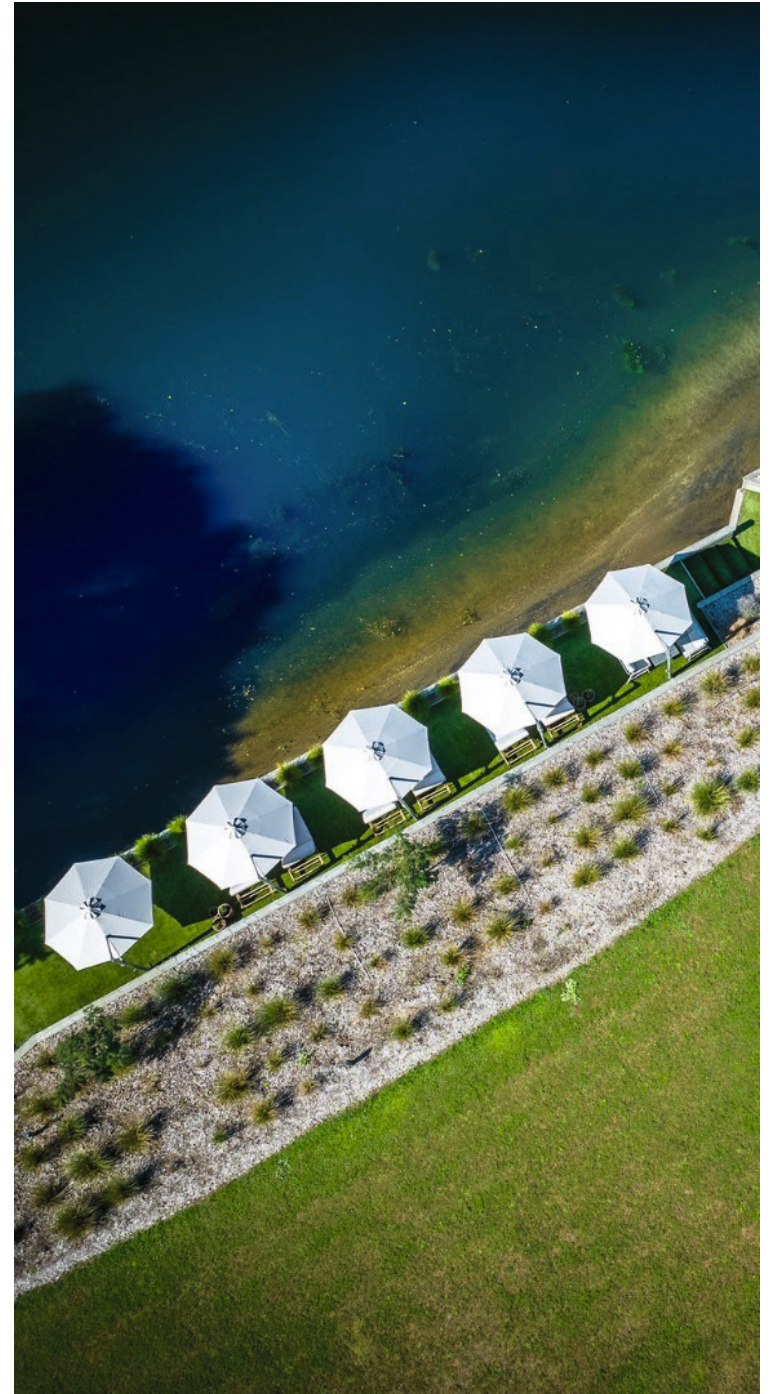

Eclipse · 4m Octagonal · Natural · Aluminium

Eclipse Cantilever Parasol

Dimensions

Measured from point to point. All measurements are rounded and are subject to change. Wind damage is not covered by the warranty.

3m Square



3.5m Square



4m Oct



3m x 4m



Closed Parasol

	3m Square	3.5m Square	4m Oct	3m x 4m
a. Mast height (cm)	283	283	283	283
b. Distance from arms to ground (cm)	68	34	80	34
Weight of parasol when folded (kg)	44	47	45	46

Open Parasol

c. Height to canopy hub (cm)	205	212	207	212
d. Total height to top of canopy (cm)	283	289	275	285
e. Height to edge of canopy (cm)	210	210	210	210
f. Distance back of mast to edge of canopy (mm)	329	375	405	329
Canopy Shade Area	9m ²	12.25 ²	11.3m ²	12m ²

Packaging Dimensions

Dimensions of cardboard packaging (cm)	295 x 51 x 30	295 x 51 x 30	295 x 51 x 30	295 x 51 x 30
Weight of boxed umbrella with spigot (kg)	60	64	62	63

Wind Rating Guide

Install Wind Rating (km/h)	65	50	65	50
Free-standing base rating (km/h)	30	Install only	30	Install only

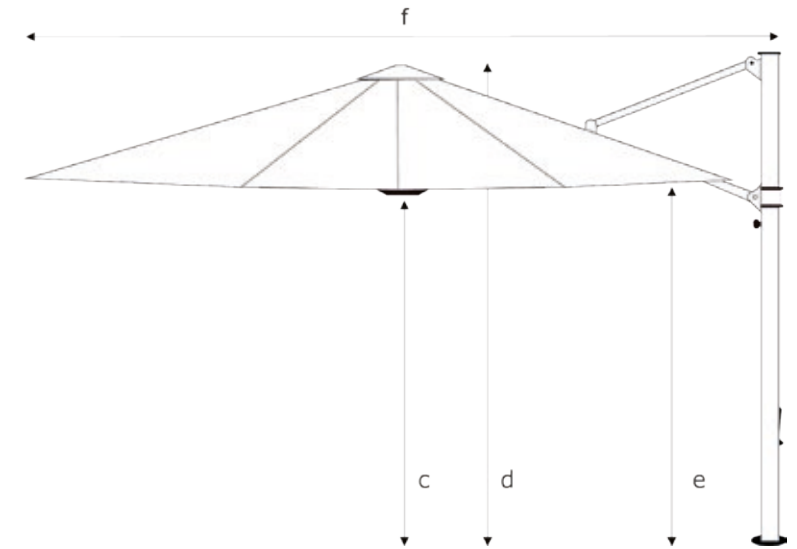
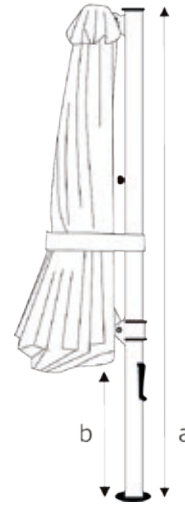

Heavy duty extruded aluminium mast



Infinity tilt system



Silent cranking system



Extruded aluminium ribs

Parasol Size	Frame	Canopy	Price (£)
3m Square	Aluminium	Acrylic	£2,499.00
3.5m Square	Aluminium	Acrylic	£2,599.00
4m Octagonal	Aluminium	Acrylic	£2,519.00
4m x 3m Rectangular	Aluminium	Acrylic	£2,599.00

Accessories	Price
Protective Cover, 900D Black	£129.00
Protective Cover, Premium Acrylic	£169.00
Stabiliser Bars	£89.00
20cm Barrel Extension	£179.00
30cm Barrel Extension	£199.00
Slimline Re-Chargeable Clip On LED Lights	£59.00

Bases	Price
Base Plate in Black or Grey	£89.00
Stainless Steel Base Plate Upgrade	£219.00
In-Ground Base	£89.00
Large Aluminium Cross Base With Cover	£918.00
Wheeled Free-Standing Base	£779.00
Timber Decking Installation Kit	£25.00
Concrete Installation Kit	£49.00

Non-standard frames have an additional £300.00 charge and a 12-15 week lead time.





“It is easy to open, close, and put on the protective cover... Plenty of shade, and can be adjusted as the sun moves across the sky.”

- Caroline B, Private Client



Nova

Centre Post Parasol

A heavy-duty commercial giant telescopic parasol that offers maximum shade protection throughout the day.

Sizes Available

3m Square, 4m Square, 5m Octagonal, 5m Square, 3.5m x 2.3m Rectangular, 4m x 3m Rectangular, Offset 3.5 x 2.5m Rectangular

The Nova can be made to order in a wide range of premium acrylic fabrics, see page 61 for the full range.

Standard Frame



Aluminium





Nova · 4m Square · Custom Brown · Printed · Aluminium





Nova · 4m Square · Black & White Stripe · Aluminium



Nova with Heat & Light Centre Post Parasol

A heavy-duty commercial giant telescopic parasol that offers maximum shade protection throughout the day.

Sizes Available

3m Square, 4m Square, 5m Octagonal, 5m Square, 3.5m x 2.3m Rectangular, 4m x 3m Rectangular, Offset 3.5 x 2.5m Rectangular

The Nova can be made to order in a wide range of premium acrylic fabrics, see page 61 for the full range.

Standard Frame



Aluminium



3 FRAME
YEARS WARRANTY



10 FADE
YEARS WARRANTY



100 WIND
RATING



801 UV
STANDARD

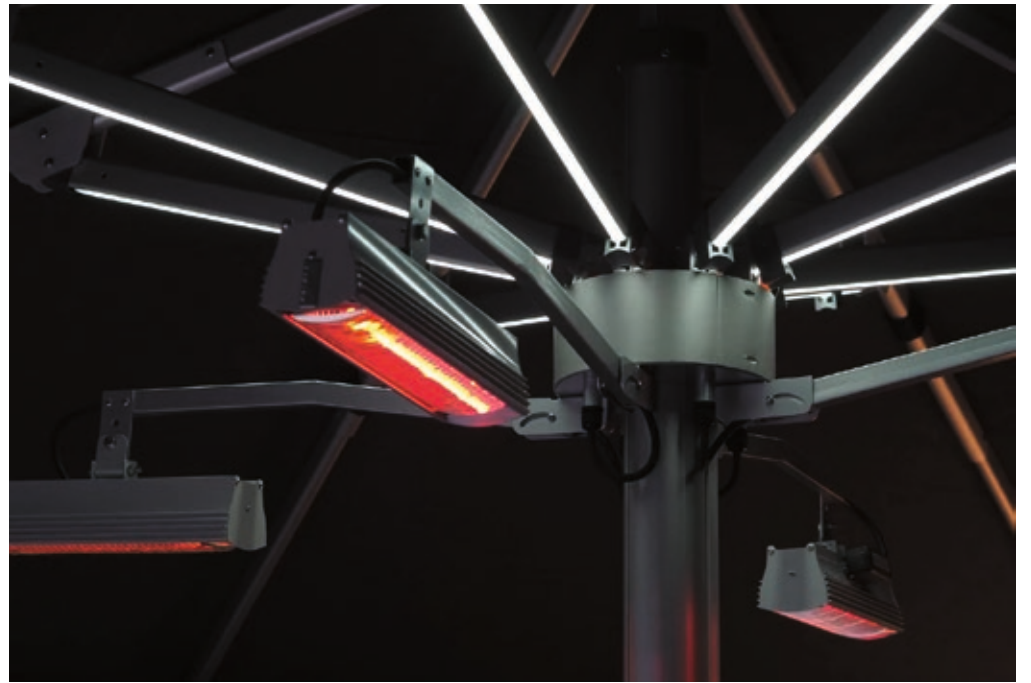

Nova with Heat & Light · 4m Square · Navy · Printed · Aluminium

Nova Centre Post Parasol

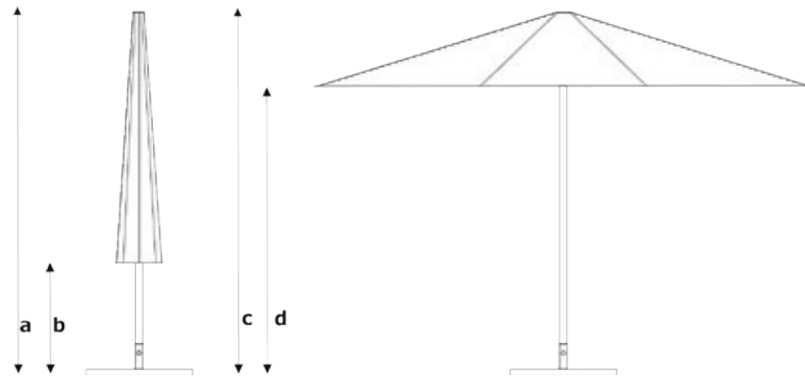

Dimensions

Measured from point to point. All measurements are rounded and are subject to change. Wind damage is not covered by the warranty.

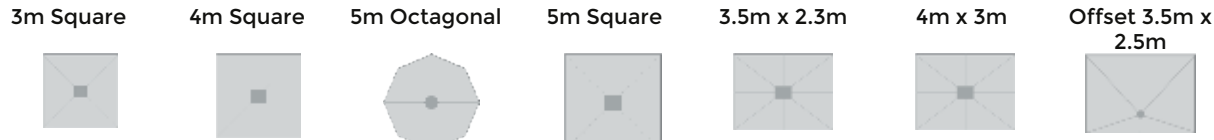

Closed Parasol

a. Height (cm)	401	418	419	446	432	432	432
b. Closed Canopy Clearance (cm)	189	133	170	92	176	183	176

Open Parasol

c. Height (cm)	285	308	308	316	311	306	311
d. Canopy edge height (cm)	231	232	232	232	243	233	243
Parasol mast diameter (mm)	94	94	94	94	94	94	94
Canopy Shade Area	9m ²	16m ²	17.6m ²	25m ²	8.05m ²	8.75m ²	8.75m ²

Packaging Dimensions

Dimensions of Cardboard packaging (cm)	420 x 46 x 46	460 x 46 x 46	460 x 46 x 46	460 x 46 x 46	460 x 46 x 46	460 x 46 x 46	460 x 46 x 46
Weight (Boxed Umbrella)(kg)	100	100	110	115	100	100	100

Wind Rating Guide

Installed Wind Rating	100	90	90	80	100	90	100
-----------------------	-----	----	----	----	-----	----	-----



Strengthened extruded aluminium mast



Telescopic crank system



Marine grade aluminium frame



Double reinforced joints

Parasol Size	Frame	Canopy	Price (£)
3m Square	Aluminium	Acrylic	£2,425.00
4m Square	Aluminium	Acrylic	£2,655.00
4m x 3m Rectangular	Aluminium	Acrylic	£2,655.00
5m Octagonal	Aluminium	Acrylic	£2,765.00
5m Square	Aluminium	Acrylic	£3,135.00
3.5m x 2.3m Rectangular	Aluminium	Acrylic	£2,309.00
Offset 3.5m x 2.5m	Aluminium	Acrylic	£2,309.00

Bases	Price
Base Plate	£149.00
In-Ground Base	£149.00
Large Aluminium Cross Base With Cover	£918.00
Seated Base Box	£1,925.00

Accessories	Price
Protective Cover	£129.00
Integrated LED Lighting	£499.00

Non-standard frames have an additional £300.00 charge and a 12-15 week lead time.



Nova · 3m Square · Natural · Aluminium



**BISTRO
BIANCONI**
RESTORANTE
& PIZZERIA

**BISTRO
BIANCONI**
RESTORANTE
& PIZZERIA

**BISTRO
BIANCONI**
RESTORANTE
& PIZZERIA

the wine buff

Interior Design Fashion



“Outdoor dining is now a permanent feature in many of our towns and cities and facilities like these support tourism businesses to provide access to outdoor dining options for longer periods of the year.”

- Eva Costello, Manager, Wild Atlantic Way at
Fáilte Ireland

“Completed in only a few weeks, Tobergal Lane ‘sparks joy’ for all who pass through it. That is a wonderful accolade for any placemaking project.”

- Councillor Michael Clarke, The Cathaoirleach
of Sligo County Council



Vista

Wall-mounted Parasol

Sensible and stylish, our Vista wall-mounted parasol is the ideal shade solution for small spaces.

Sizes Available

1.9m Square, 2.3m Square, 2.7m Hexagonal, 3m Hexagonal

Standard Colours

A large range of non-standard colours are available (see page 61) with an additional charge of £149.00 and increased production time.

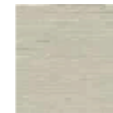

Natural



Slate

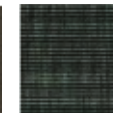

Smoked
Tweed

Standard Frames



Aluminium



3 FRAME
YEARS WARRANTY



5 FADE
YEARS WARRANTY



50 WIND
RATING



801 UV
STANDARD



Vista · 3m Hexagonal · Natural · Aluminium

Vista Wall-mounted Parasol

Dimensions

Measured from point to point.
All measurements are rounded
and are subject to change.
Wind damage is not covered by
the warranty.

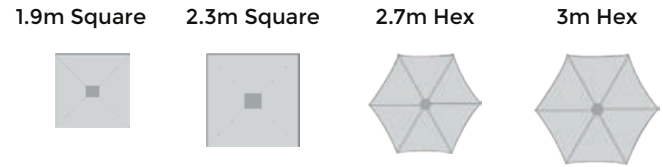

Open Parasol

	1.9m Square	2.3m Square	2.7m Hex	3m Hex
a. Full length with evolution arm (cm)	286	315	310	329
b. Evolution arm length (cm)	210	210	210	210
c. Width of Canopy (cm)	190	230	270	300
d. Height of canopy pole (cm)	77	77	77	77
Canopy shade area	3.6m ²	5.3m ²	4.7m ²	5.8m ²
e. Wall bracket (cm)	30h x 9w x 5d	30h x 9w x 5d	30h x 9w x 5d	30h x 9w x 5d

Packaging Dimensions

	1.9m Square	2.3m Square	2.7m Hex	3m Hex
Dimensions of cardboard packaging (cm)	145 x 41 x 21	145 x 41 x 21	145 x 41 x 21	145 x 41 x 21
Weight of boxed umbrella (kg)	11	12	13	15

Wind Rating Guide

	1.9m Square	2.3m Square	2.7m Hex	3m Hex
Install Wind Rating (km/h)	50	30	40	30

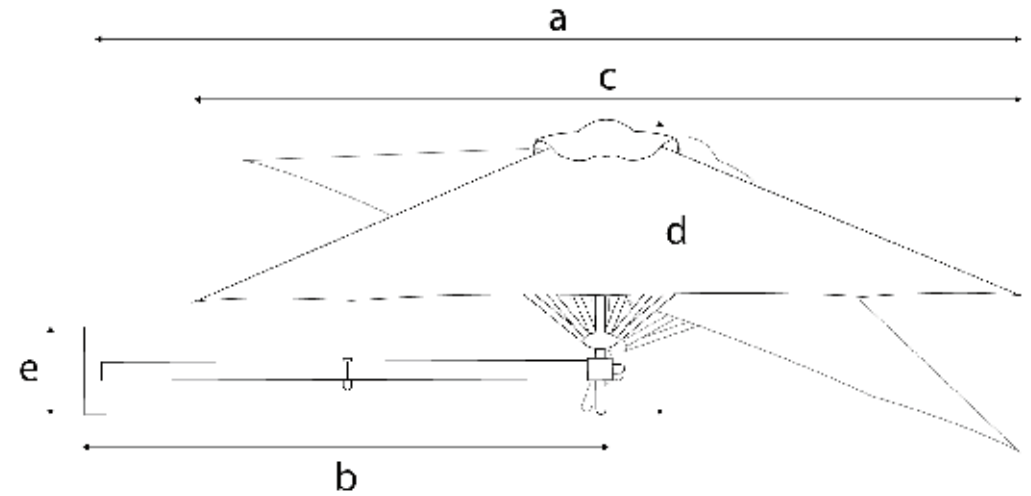

Multi-position arm



Easy tilt adjustment



Shade with no base

Size	Frame	Canopy	Price (£)
1.9m Square	Aluminium	Acrylic	£1,084.00
2.3m Square	Aluminium	Acrylic	£1,339.00
2.7m Hexagonal	Aluminium	Acrylic	£1,338.00
3m Hexagonal	Aluminium	Acrylic	£1,474.00

Accessories	Price
Protective Cover	£89.00
Slimline Re-Chargeable Clip On LED Lights	£59.00





NEW

Greenwich

Centre Post Parasol

The Greenwich parasol is elegant, refined and sure to satisfy your need for shade in any upscale commercial or residential setting.

Sizes Available

1.9m Square, 3.2m Octagonal, 2.5m x 3.4m Rectangular, 3m x 4m Rectangular

Standard Colours

A large range of non-standard colours are available (see page 61) with an additional charge of £149.00 and increased production time.



Black and White Stripe

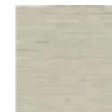

Natural

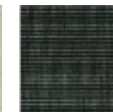

Smoked Tweed



Black and White Salcombe Stripe

Standard Frame



Aluminium



5 FRAME YEARS WARRANTY



10 FADE YEARS WARRANTY



60 WIND RATING km/h



801 UV STANDARD



Greenwich · 1.9m Square · Black and White Stripe · Aluminium

Greenwich Centre Post Parasol

Dimensions

Measured from point to point. All measurements are rounded and are subject to change. Wind damage is not covered by the warranty.

1.9m Square



3.2m Oct



2.5m x 3.4m



3m



Frame Specifications

	1.9m Square	3.2m Oct	2.5m x 3.4m	3m
Post (outside diameter)(mm)	38	38	50	50

Closed Parasol

a. Height (cm)	259	274	292	292
b. Closed canopy clearance (cm)	106	101	70	70

Open Parasol

c. Height to edge of canopy (cm)	193	208	218	221
Canopy shade area	4m ²	7.2m ²	8.5m ²	9m ²

Packaging Dimensions

Dimensions of cardboard packaging (cm)	180 x 21 x 21	200 x 24 x 24	300 x 29 x 26	300 x 29 x 26
Weight of boxed parasol (kg)	10	16	23	23

Wind Rating Guide

Install Wind Rating (km/h)	60	60	50	50
Free-standing base rating (km/h)	30	30	25	25

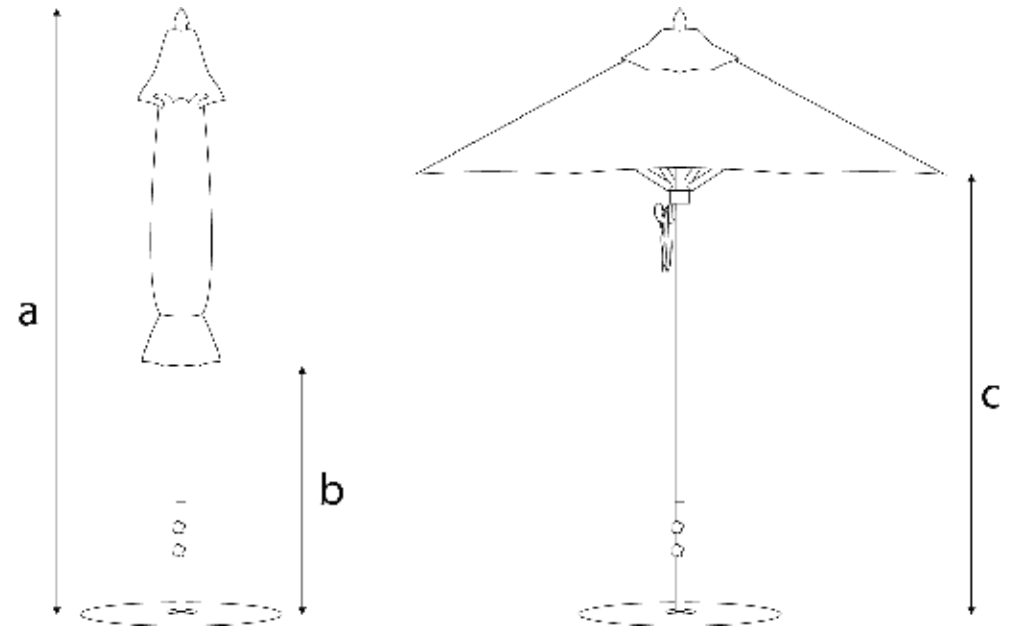

Commercial pulley system

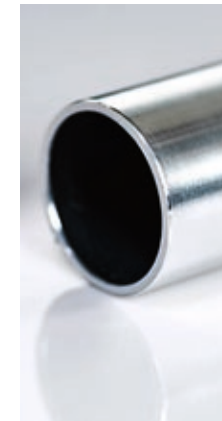

Polished silver anodised aluminium finish



High impact polymer joints



Extruded aluminium ribs

Size	Frame	Canopy	Price (£)
1.9m Square	Aluminium	Acrylic	£429.00
3.2 Octagonal	Aluminium	Acrylic	£569.00
2.5m x 3.4m Rectangular	Aluminium	Acrylic	£749.00
3m Square	Aluminium	Acrylic	£739.00

Bases	Price
14kg Steel Base	£109.00
19kg Steel Base	£129.00
35kg Concrete Ring Base	£129.00
45kg Concrete Ring Base	£159.00
35kg Wheeled Base	£299.00
35kg Galvanised Steel Base	£339.00
45kg Galvanised Steel Base	£409.00
In-Ground Base	£129.00
Cam Locking Base	£129.00

Accessories	Price
Small Protective Cover	£99.00
Slimline Re-Chargeable Clip On LED Lights	£59.00
PVC Sandbags	£49.00

Non-standard Frames - £300.00 additional charge - 12-15 week lead time.





NEW

Monterey

Centre Post Parasol

The Monterey is designed to allow you to bring commercial durability home to your cherished outdoor living space.

Sizes Available
2.7m Octagonal

Standard Colours

A large range of non-standard colours are available (see page 61) with an additional charge of £149.00 and increased production time.



Natural



Slate



Smoked
Tweed

Standard Frame



Aluminium



3 YEARS FRAME WARRANTY



5 YEARS FADE WARRANTY



50 km/h WIND RATING



801 UV STANDARD



Monterey · 2.7m Octagonal · Black · Aluminium

Monterey Centre Post Parasol

Dimensions

Measured from point to point.
All measurements are rounded
and are subject to change. Wind
damage is not covered by the
warranty.

2.7m Oct



Open Parasol

a. Canopy edge height (cm)	205
b. Canopy height when tilted - Lower (cm)	155
c. Height from top of base to underside of winder handle (cm)	100
d. Canopy height when tilted - Upper (cm)	260
Canopy shade area	5.2m ²

Closed Parasol

e. Height (cm)	271
f. Closed canopy clearance (cm)	125

Frame Specifications

Post (outside diameter x thickness x length (cm))	3.8 x 0.2 x 260
---	-----------------

Packaging Dimensions

Dimensions of cardboard packaging (cm)	200 x 20 x 20
Weight of boxed parasol (kg)	11

Wind Rating Guide

Install Wind Rating (km/h)	50
Free-standing 30kg concrete base rating (km/h)	30

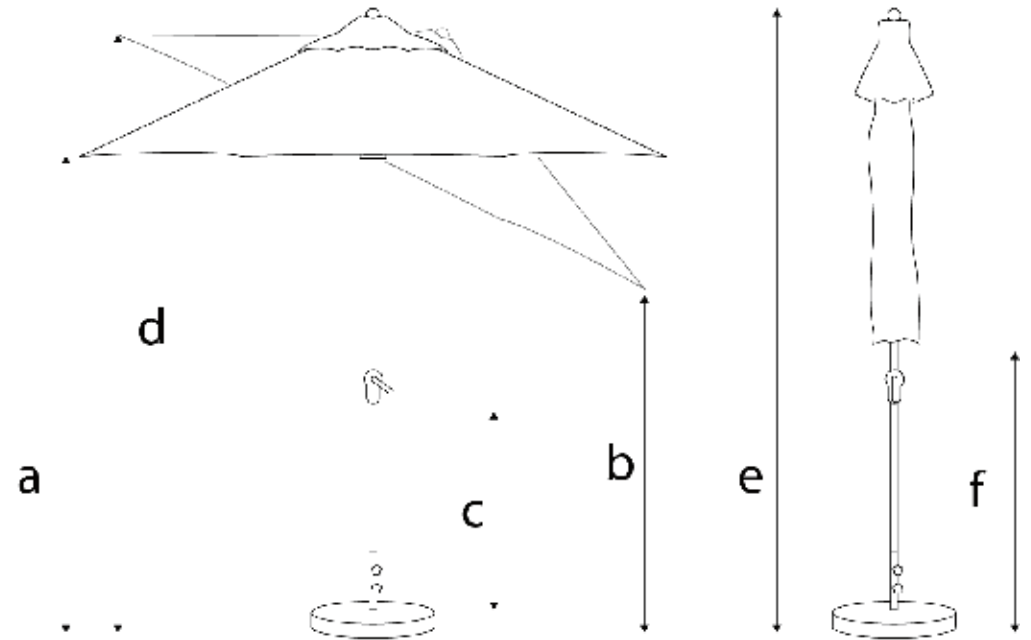

1.5" Diameter centre pole



Commercial crank auto-tilt



Strong polymer joints and fibre glass ribs

Size	Frame	Canopy	Price (£)
2.7m Octagonal	Aluminium	Acrylic	£369.00

Bases	Price
14kg Steel Base	£109.00
19kg Steel Base	£129.00
35kg Concrete Ring Base	£129.00
45kg Concrete Ring Base	£159.00
35kg Wheeled Base	£299.00
35kg Galvanised Steel Base	£339.00
45kg Galvanised Steel Base	£409.00
In-Ground Base	£129.00
Cam Locking Base	£129.00

Accessories	Price
Protective Cover	£79.00
Slimline Re-Chargeable Clip On LED Lights	£59.00
PVC Sandbags	£49.00

Non-standard Frames - £300.00 additional charge - 12-15 week lead time.





Café Series

Centre Post Parasol

Our stylish Café Series parasol is perfect for cafés, bars and restaurants, as well as residential use, with a durable olefin canvas in several contemporary colours.

Sizes Available

2m Square, 2.8m Octagonal, 3m Square, 4.2m Octagonal

Standard Colours

A large range of non-standard colours are available (see page 61) with an additional charge of £149.00 and increased production time.



Black



Natural



Slate

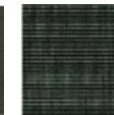

Smoked
Tweed

Standard Frames



Aluminium



3 YEARS WARRANTY



5 YEARS WARRANTY



60 WIND RATING



801 UV STANDARD



Cafe Series · 2.8m Octagonal · Black · Aluminium

Cafe Series Centre Post Parasol

Dimensions

Measured from point to point. All measurements are rounded and are subject to change. Wind damage is not covered by the warranty.

2m Square



2.8m Oct



3m Square



4.2m Oct



Frame Specifications

Post (outside diameter x thickness x length (cm))	4 x 0.2 x 260	4 x 0.2 x 260	5 x 0.2 x 290	5 x 0.2 x 290
Long arms (cm)	18 x 24 x 0.12	18 x 24 x 0.12	18 x 30 x 0.12	18 x 30 x 0.12

Closed Parasol

a. Height (cm)	260	260	290	290
b. Closed canopy clearance (cm)	100	100	75	75

Open Parasol

c. Height to edge of canopy (cm)	205	205	210	210
Canopy shade area	4m ²	5.5m ²	9m ²	12.4m ²

Packaging Dimensions

Dimensions of cardboard packaging (cm)	170 x 23 x 23	170 x 23 x 23	297 x 25 x 25	297 x 25 x 25
Weight of boxed parasol (kg)	12	14	22	24

Wind Rating Guide

Install Wind Rating (km/h)	60	60	60	60
Free-standing base rating (km/h)	30	30	30	30

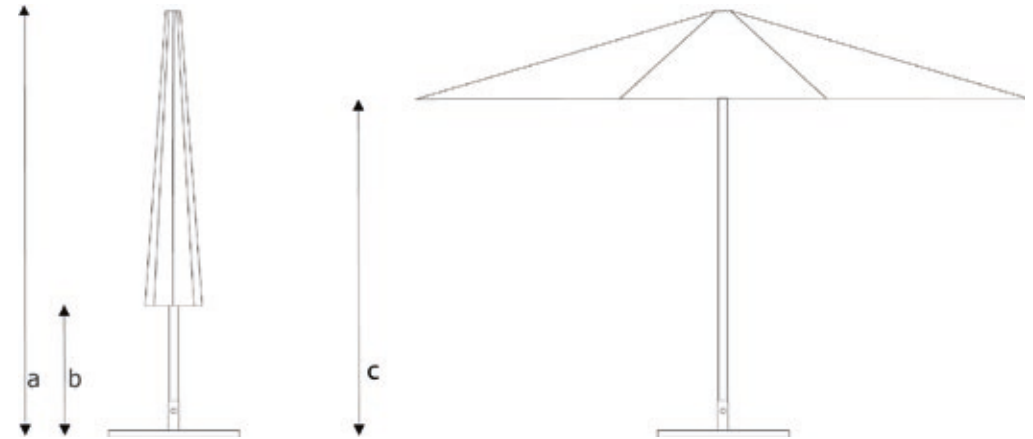

Rope and pin system



Strong nylon connectors



Silver anodised frame and arms

Size	Frame	Canopy	Price (£)
2m Square	Aluminium	Acrylic	£379.00
2m Square	Aluminium	Olefin	£289.00
2.8m Octagonal	Aluminium	Acrylic	£479.00
2.8m Octagonal	Aluminium	Olefin	£369.00
3m Square	Aluminium	Acrylic	£669.00
3m Square	Aluminium	Olefin	£509.00
4.2m Octagonal	Aluminium	Acrylic	£689.00
4.2m Octagonal	Aluminium	Olefin	£539.00
Bases			Price
14kg Steel Base			£109.00
19kg Steel Base			£129.00
35kg Concrete Ring Base			£129.00
45kg Concrete Ring Base			£159.00
35kg Wheeled Base			£299.00
35kg Galvanised Steel Base			£339.00
45kg Galvanised Steel Base			£409.00
In-Ground Base			£129.00
Cam Locking Base			£129.00
Accessories			Price
Small Protective Cover			£49.00
Large Protective Cover			£69.00
Slimline Re-Chargeable Clip On LED Lights			£59.00
PVC Sandbags			£49.00





NEW

Oakwood

Premium Deckchair

With its heavy-duty solid wood construction, the Oakwood Beach Chair is designed for ultimate longevity in coastal environments.

Standard Colours

A large range of non-standard colours are available (see page 61) with an additional charge and increased production time.



Yellow
and
White
Half
Stripe

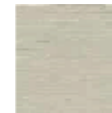

Natural



Stainless steel hinges and hardware safeguard against rust.

Item	Fabric Colour	Price (£)
Deckchair	Standard Colour	£198.00
Deckchair	Non-Standard Colour	£259.00

02. Bespoke



Custom Printing

Make a lasting impression with a high-quality, custom-branded parasol. Whether for a café, restaurant, or outdoor event, our premium parasols combine durability, elegance, and full customisation to showcase your brand in the best light.

We offer dye-sublimation printing for full bespoke coverage, and heat transfer vinyl for logos and text on stock coloured fabric.

Ready to elevate your outdoor space with a custom-branded parasol? Contact us today to discuss your design and get a personalised quote.

Tel: 01925 859 960

E-mail: info@instashade.co.uk

Web: www.instashade.co.uk

01. Select Parasol

Choose the parasol you desire and contact us with your design ideas or branding requirements. We will then be able to provide a quote based on your needs and provide a design proof.

03. Approve Design

Once you are happy with your design proof, we will arrange production of your printed parasol, giving you clear timelines.

02. Send Branding

Once our team has been in touch, we will kindly ask you to send any branding and logos. Our in-house design team can create your design from scratch or simply work with your own designs.

04. Receive Parasol

Once your custom printed parasol has been printed and assembled, we will arrange for dispatch and or installation.





Vinyl Printing

This style of printing is perfect for text and logos that are isolated on a stock colour canopy. Heat transfer vinyl is expertly printed and pressed in-house at our Cheshire-based studio to ensure durability and give a quality finish that stands out. Of our three printing options, vinyl is the most budget-friendly option, as you can choose to have as few or as many of the sides of your parasol printed as you would like. It also comes with our shortest standard lead time, perfect if you're on a tight schedule.

It is important to keep in mind however that vinyl print does have limitations on the scale of your artwork, and the design cannot go all the way to the edge of the canopy.





Screen Printing

Screen print can be applied to any of our existing fabric colours and is best for imagery with up to 5 colours, however unlike vinyl the print can be applied all the way to the edge of the canopy with no limitations to size.

UV Printing

UV printing allows for full edge to edge coverage of the parasol with your artwork to create a strong impression for your brand. There are no limits to scale and colour meaning your creativity can take centre stage. Our UV printing has far higher UV properties when compared to standard dye-sublimation, meaning the print will not fade.





Valance Options

Our bespoke valance collection allows each parasol to be tailored with a distinctive, design-led finish. The range includes the elegant Belgravia, the contemporary Hove, the decorative Hampstead Fringe, and the statement Salcombe Stripe, each offering a unique aesthetic to suit both classic and modern outdoor schemes. Crafted from our premium performance fabrics, every valance is designed to enhance visual identity while maintaining exceptional durability, UV resistance and long-term colour stability. Ideal for residential, hospitality and branded environments, these bespoke details create a refined and recognisable signature.



Belgravia Valance



Hove Valance



Salcombe Stripe



Hampstead Fringe



Trims

Our custom trim and colour options allow each parasol to be tailored with complete design flexibility, creating a truly bespoke finish. Beyond refined edge trims, we offer the ability to customise individual elements, including contrasting trims, alternating canopy panels, and accent-coloured vents, enabling striking combinations or subtle tonal detailing. Available in a curated selection of premium colours and finishes, every component can be specified to complement or enhance the main canopy fabric. Whether the goal is understated elegance or bold brand expression, we can accommodate virtually any colour configuration to achieve a cohesive and elevated aesthetic.

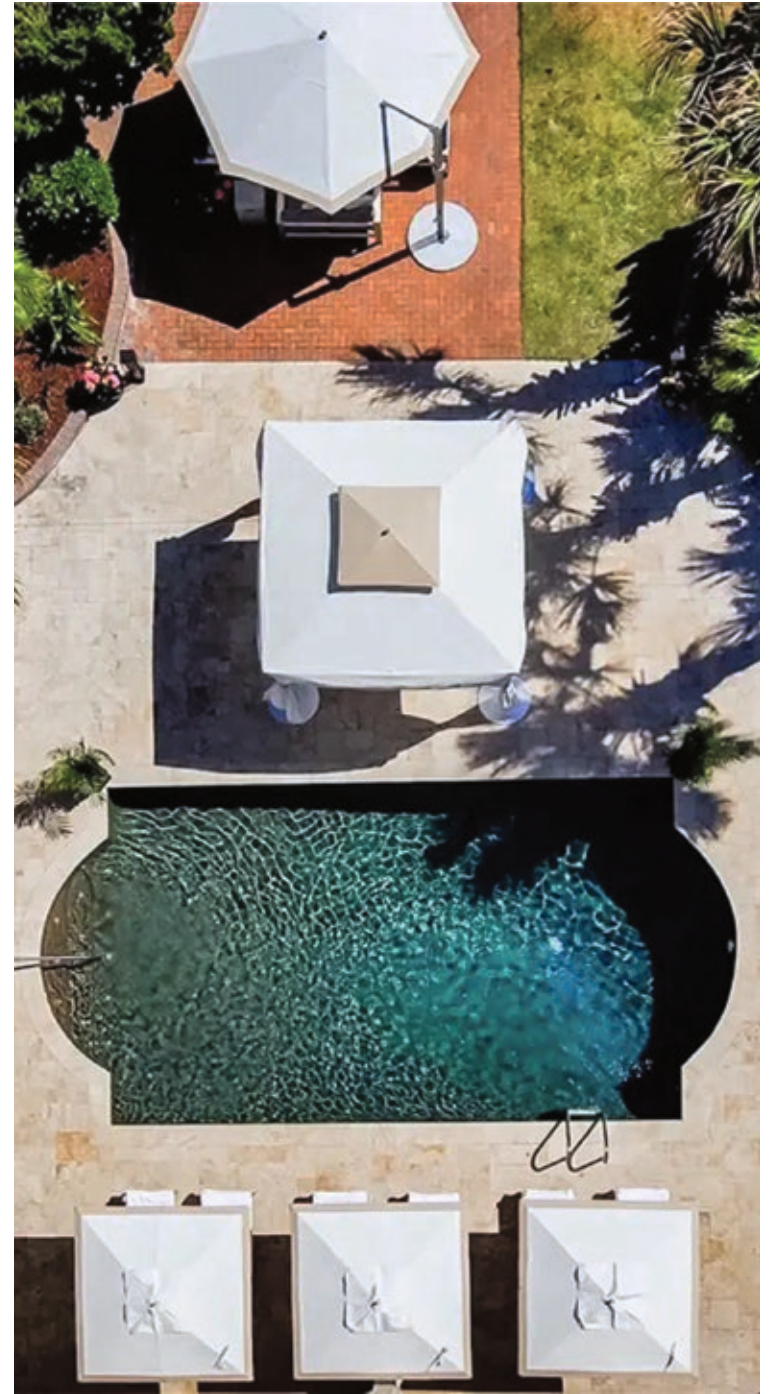

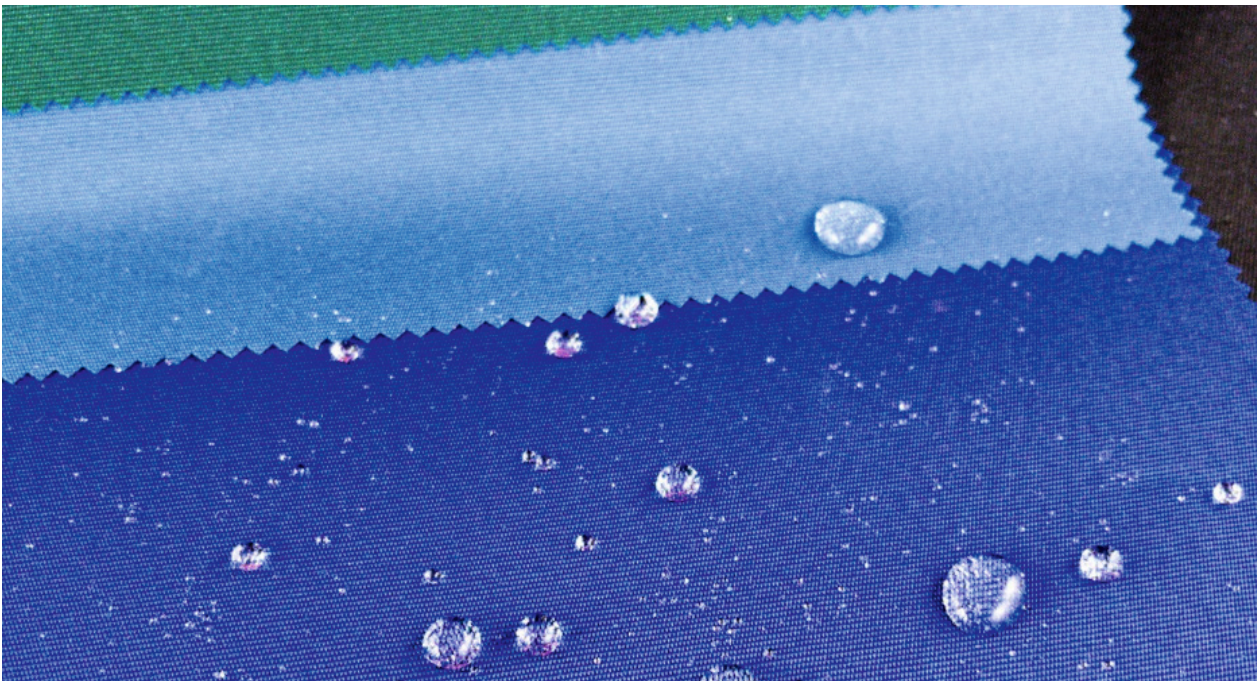

Our Fabrics

Our 100% solution-dyed acrylic fabrics originate from a liquid acrylic polymer solution. Colour pigments are then added to the polymer solution before the fibre is extruded.

During the spinning process, the liquid is transformed into yarn that is fully dyed. This means the colour does not just remain on the surface, but it is consistent right from the heart of the yarn.

This results in 100% solution dyed acrylic fabrics that have exceptional colour retention as well as excellent technical properties and UV and weather resistance.





Olefin Canvas

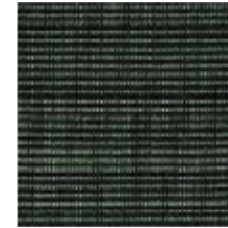

Smoked Tweed



Slate



Natural

Premium Acrylic Canvas Stripes



Red Stripe



Orange Stripe



Yellow Stripe



Teal Stripe



Turquoise Stripe



Blue Stripe



Navy Stripe



Black Stripe



Premium Acrylic Canvas



Burgundy



Vermilion



Red



Chestnut



Salmon



Pumpkin



Orange



Yellow



Pistachio



Khaki



Forest Green

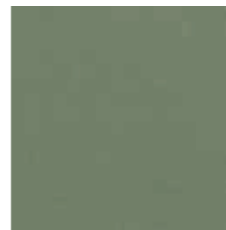

Jade



Teal



Turquoise



Sapphire



Light Blue



Steel Blue



Pacific Blue



Sailors Navy



Lily



Black



Carbon



Charcoal Grey

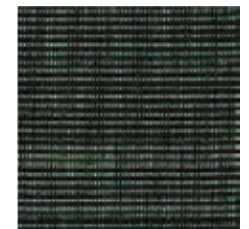

Smoked Tweed



Cadet Grey

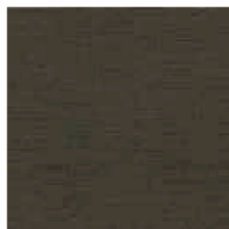

Slate



Chocolate



Tan



Natural



Pearl



Linen



White

*Fabric colours may vary slightly from printed swatches shown above



Frame Options

We have a stunning range of frame options to perfectly complement your chosen canopy colour or fit seamlessly with your existing garden furniture. Onyx, Carbon and Alpine White create a sleek, modern finish that works well with every colour. Wood Effect and Heather Willow have a more natural look perfect for gardens and other outdoor spaces.

Please note that not all frame finishes are available for every parasol.

Non-standard frames have an additional £300.00 charge and a 12-15 week lead time.

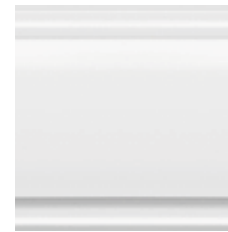

Alpine White

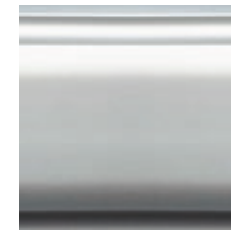

Aluminium



Carbon

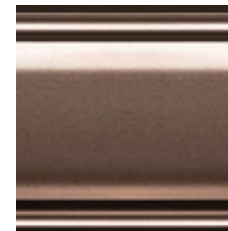

Desert Bronze

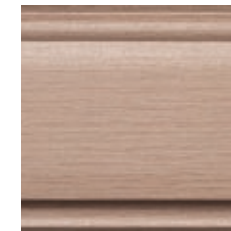

Heather Willow



Onyx



Wood Effect



03. Bases & Installation

Free-standing Bases



Steel Base
14kg £109.00
19kg £129.00

Compatible with:
Café Series, Greenwich and
Monterey



Concrete Ring Base
35kg £129.00
45kg £159.00

Compatible with:
Café Series, Greenwich and
Monterey



35kg Wheeled Base
40mm Spigot £299.00
50mm Spigot £299.00

Compatible with:
Café Series, Greenwich and
Monterey

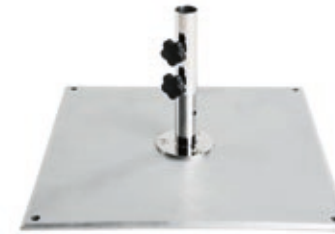

Galvanised Steel Base
35kg £339.00
45kg £409.00

Compatible with:
Café Series, Greenwich and
Monterey



Cross base with Pavers
£339.00

Compatible with: Aurora
Comes with 4 x 25kg concrete blocks



Aluminium Cover for Cross
Base
£918.00

Compatible with:
Nova and Eclipse



Wheeled Free-standing
Base
£779.00

Compatible with:
Aurora and Eclipse



Seated Base Box
£1,925.00

Compatible with:
Nova

Cushion and box can be customised
to your choice of colour.

Installed Bases



Café Series, Greenwich and Monterey In-ground Base
£129.00



Eclipse and Aurora In-ground Base
£89.00



Nova In-ground Base
£149.00



Stainless Steel Spigot Upgrade
£219.00

Compatible with:
Eclipse and Aurora



Cam Locking Base
£129.00

Compatible with:
Café Series, Greenwich and Monterey



Eclipse and Aurora Base Plate
£89.00

Available in:
Black and Grey



Stainless Steel Base Plate Upgrade
£219.00

Compatible with:
Eclipse and Aurora



Nova Base Plate Upgrade
£149.00



Concrete Installation Kit
£49.00

Compatible with:
Eclipse and Aurora



Decking Installation Kit
£25.00

Compatible with:
Eclipse and Aurora



Our Installation Service

We have a dedicated in-house installation team who travel throughout the UK and Europe to install our parasols in both domestic and commercial settings. Installation can include the fitting of the in-ground base which is perfect for paving slabs, grass or gravel and the base plates fitted into solid concrete patios or onto decking (wood or millboard).

As each of our orders are so bespoke and each location requires varying travel times and installation methods, the price for installations will be quoted at the point of order.

During our busy spring and summer season, there can be a longer waiting period for your selected installation dates. We would highly recommend booking this as much in advance as possible if you would like installation between April and August. Installation dates can only be confirmed for confirmed orders and when your deposit has been paid.



All of our luxury parasols come complete with a spigot allowing you to connect your parasol to the base beneath. Our removable and semi-permanent bases are chosen separately.

If you intend to keep your parasol in one place, we recommend the semi-permanent option for the following reasons:

- Maximum security and stability.
- Increased wind resistance.
- Umbrella can be easily removed.
- All installation options.
- No large base.

Accessories



Stabiliser Bars
Aurora £69.00
Eclipse £89.00



Slimline Re-chargeable
Clip on LED Lights
£59.00



Barrel Extension
20cm £179.00
30cm £199.00

Compatible with:
Eclipse and Aurora



Pair of PVC Sandbags
£49.00

Compatible with:
Café Series and Greenwich



Aurora & Eclipse Protective
Cover
900D Black £129.00
Premium Acrylic £169.00



Café Series Protective
Cover
Small £49.00
Large £69.00



Nova Protective Cover
£195.00



Monterey Protective Cover
£79.00



Greenwich Protective Cover
£99.00



Vista Protective Cover
900D Black £59.00
Non-Std Premium Acrylic
£89.00

InstaShade

PARASOLS

OUTDOOR SHADE EXPERTS

A family-run business rooted in
over 20 years of industry expertise

01925 859 960 | info@instashade.co.uk | www.instashade.co.uk