

InstaShade
PARASOLS

TIMELESS SHADE
CRAFTED FOR COMMERCIAL & RESIDENTIAL SPACES



[INSTASHADE.CO.UK](https://www.instashade.co.uk)

InstaShade

PARASOLS

OUTDOOR SHADE EXPERTS

A family-run business rooted in over
20 years of industry expertise

01925 859 960 | info@instashade.co.uk | www.instashade.co.uk



Welcome

Revitalise your outdoor space with sleek and intelligent outdoor solutions crafted by Instashade. We're dedicated to delivering exceptional parasols that seamlessly blend style and practicality. Explore our exquisite range of parasols, meticulously designed to elevate your outdoor experience with both elegance and functionality.

As a family-run business established in 2006, our expertise in the industry and strong client relationships make us a trusted choice for your outdoor needs, whether you're a large corporate organisation or a homeowner with an eye for exterior design.

We pride ourselves on excellent customer service, and supply only the finest, most innovative parasols on the market. All of our products include a minimum two-year warranty, to give you confidence in the quality of our parasols.

If you need guidance in selecting the perfect parasol for your needs, our team is here to assist you every step of the way. Your satisfaction is our priority, and we look forward to helping you transform your outdoor space with style and functionality.

Our Team

Tel: 01925 859 960
 E-mail: info@instashade.co.uk
 Web: www.instashade.co.uk



Contents

01. Products	6	03. Bases & Installation	66
Aurora Cantilever Parasol	7	Free-Standing bases	67
Eclipse Cantilever Parasol	13	Installed Bases	68
Nova Centre Post Parasol	19	Our Installation Service	69
Nova With Heat & Light	23	Accessories	71
Vista Wall-Mounted Parasol	29		
Greenwich Centre Post Parasol	33		
Monterey Centre Post Parasol	37		
Café Series Centre Post Parasol	41		
Oakwood Deckchair	45		
02. Bespoke	48		
Custom Printing	49		
Valance Options	55		
Trims	57		
Our Fabrics	59		
Frame Options	63		

01. Products



Aurora

Cantilever Parasol

Introducing an elegant parasol, meticulously designed for effortless usability, perfect for homes and boutique hospitality.

Sizes Available
2.5m Square (Aluminium frame only), 2.8m Square, 3.8m Octagonal

Standard Colours
A large range of non-standard colours are available (see page 61) with an additional charge of £149.00 and increased production time.

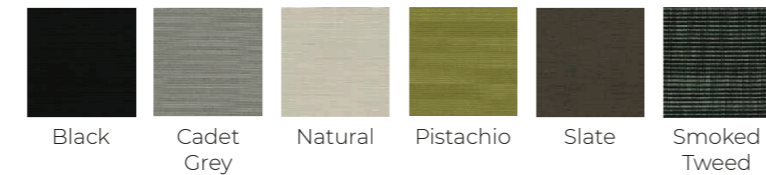

Standard Frames



Aurora · 3.5m Octagonal · Natural · Aluminium

Aurora Cantilever Parasol

Dimensions

Measured from point to point. All measurements are rounded and are subject to change. Wind damage is not covered by the warranty.

2.5m Square



2.8m Square



3.5m Oct



Closed Parasol

	2.5m Square	2.8m Square	3.5m Oct
a. Mast height (cm)	280	282	282
b. Distance from arms to ground (cm)	96	76	100
Weight of parasol when folded (kg)	26	27	27

Open Parasol

	2.5m Square	2.8m Square	3.5m Oct
c. Height to canopy hub (cm)	198	210	200
d. Total height to top of canopy (cm)	254	274	264
e. Height to edge of canopy (cm)	189	215	210
f. Distance back of mast to edge of canopy (mm)	250	310	360
Canopy Shade Area		7.8m ²	8.6m ²

Packaging Dimensions

	2.5m Square	2.8m Square	3.5m Oct
Dimensions of cardboard packaging (cm)	297 x 51 x 31	297 x 51 x 31	297 x 51 x 31
Weight of boxed umbrella with spigot (kg)	60	60	60

Wind Rating Guide

	2.5m Square	2.8m Square	3.5m Oct
Install Wind Rating (km/h)	50	50	50
Free-standing base rating (km/h)	30	30	30

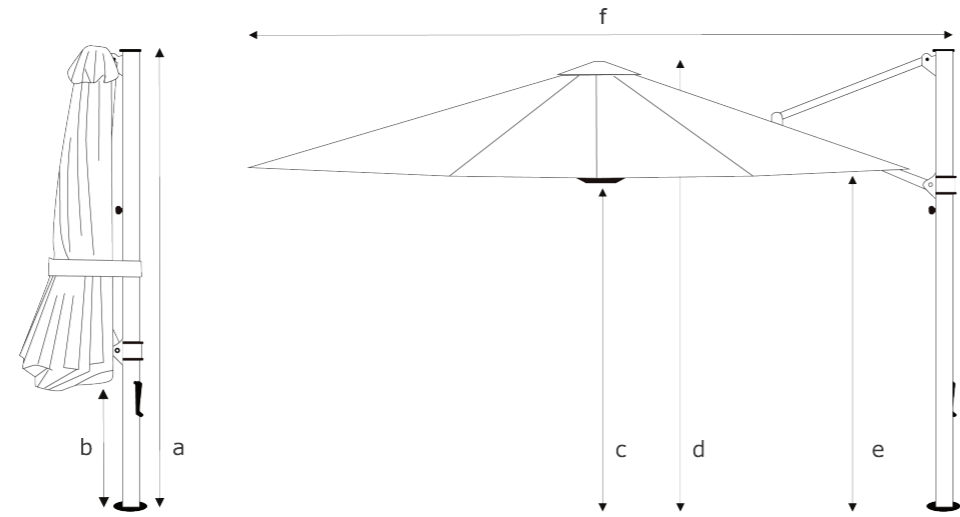

Bi-directional winder handle



Infinity tilt system



Easy glide slider car



Strengthened rib profile

Parasol Size	Frame	Canopy	Price
2.5m Square	Aluminium	Olefin	£1,579.00
2.8m Square	Aluminium	Olefin	£1,599.00
3.5m Octagonal	Aluminium	Olefin	£1,629.00

Accessories

	Price
Protective Cover, 900D Black	£129.00
Protective Cover, Premium Acrylic	£169.00
Stabiliser Bars	£69.00
20cm Barrel Extension	£179.00
30cm Barrel Extension	£199.00
Slimline Re-Chargeable Clip On LED Lights	£59.00

Bases

	Price
Base Plate in Black or Grey	£89.00
Stainless Steel Base Plate Upgrade	£219.00
In-Ground Base	£89.00
Cross base with Pavers	£339.00
Wheeled Free-Standing Base	£779.00
Timber Decking Installation Kit	£25.00
Concrete Installation Kit	£49.00

Non-standard frames have an additional £300.00 charge and a 12-15 week lead time. Wood Effect frames have an additional £269.00 charge.





“The best thing about this Instashade Parasol is that we can have protection over the seating area and then swing it around so that the family can gather around the table and we are still protected from the sun.”

- Ben Fogle



Eclipse

Cantilever Parasol

The Eclipse parasol is deigned for longevity and durability. It is perfectly suited for both residential and commercial use.

Sizes Available
 3m Square, 3.5m square, 4m Octagonal, 3m x 4m Rectangular

Standard Colours
 A large range of non-standard colours are available (see page 61) with an additional charge of £149.00 and increased production time.



Standard Frames

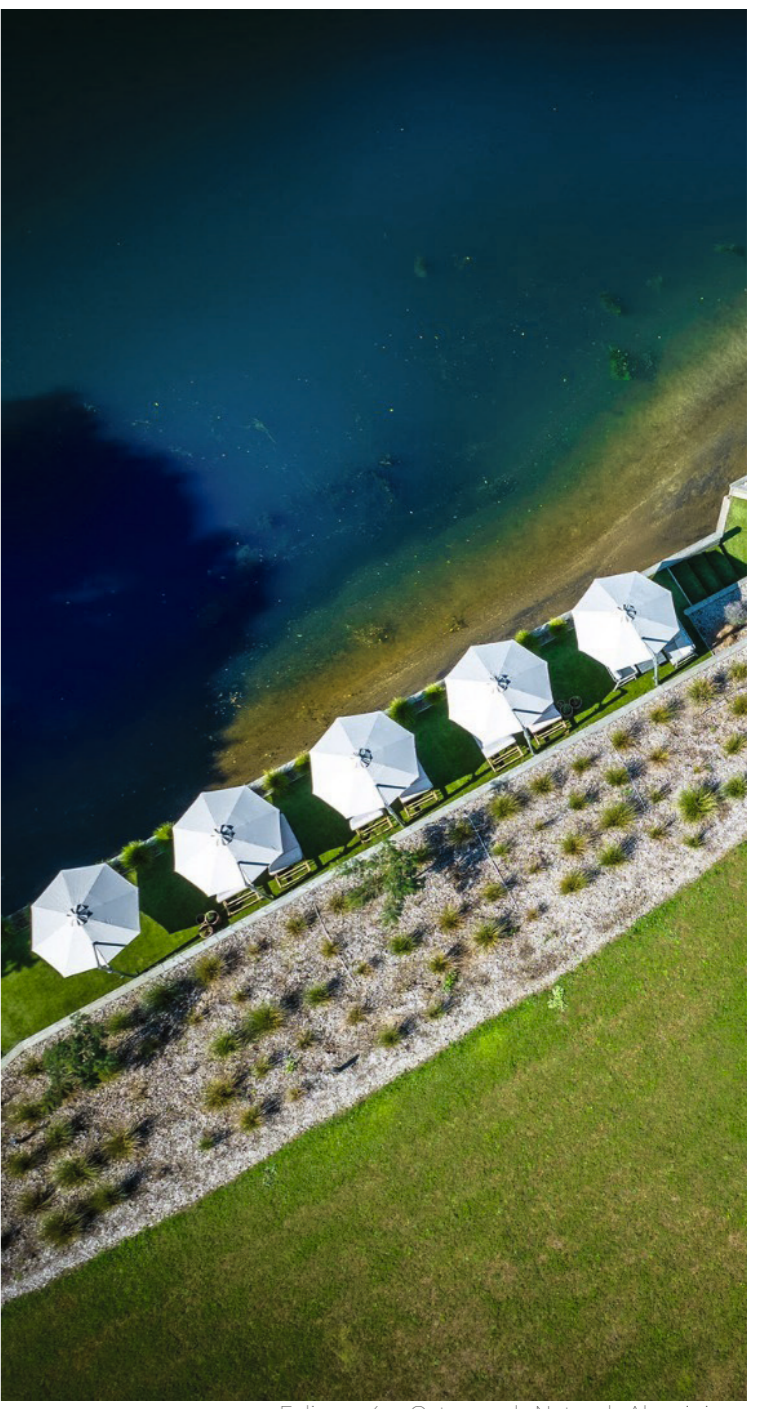
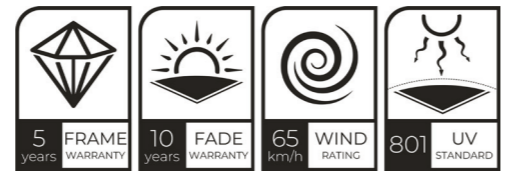

Eclipse · 4m Octagonal · Natural · Aluminium

Eclipse Cantilever Parasol

Dimensions

Measured from point to point. All measurements are rounded and are subject to change. Wind damage is not covered by the warranty.

3m Square 3.5m Square 4m Oct 3m x 4m



Closed Parasol

	3m Square	3.5m Square	4m Oct	3m x 4m
a. Mast height (cm)	283	283	283	283
b. Distance from arms to ground (cm)	68	34	80	34
Weight of parasol when folded (kg)	44	47	45	46

Open Parasol

c. Height to canopy hub (cm)	205	212	207	212
d. Total height to top of canopy (cm)	283	289	275	285
e. Height to edge of canopy (cm)	210	210	210	210
f. Distance back of mast to edge of canopy (mm)	329	375	405	329
Canopy Shade Area	9m ²	12.25 ²	11.3m ²	12m ²

Packaging Dimensions

	3m Square	3.5m Square	4m Oct	3m x 4m
Dimensions of cardboard packaging (cm)	295 x 51 x 30	295 x 51 x 30	295 x 51 x 30	295 x 51 x 30
Weight of boxed umbrella with spigot (kg)	60	64	62	63

Wind Rating Guide

Install Wind Rating (km/h)	65	50	65	50
Free-standing base rating (km/h)	30	Install only	30	Install only

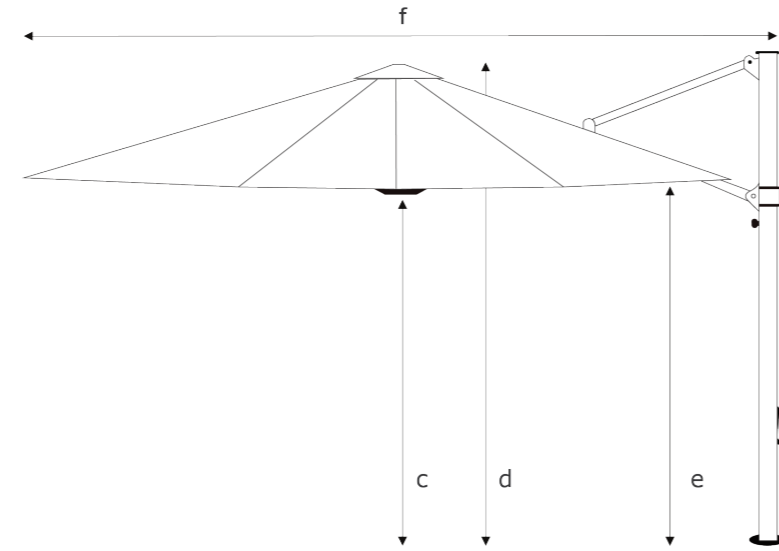
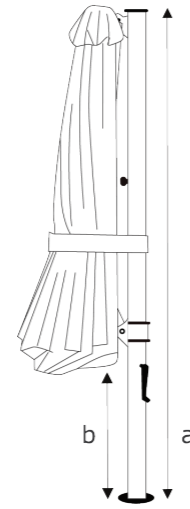

Heavy duty extruded aluminium mast



Infinity tilt system



Silent cranking system



Extruded aluminium ribs

Parasol Size	Frame	Canopy	Price (£)
3m Square	Aluminium	Acrylic	£2,499.00
3.5m Square	Aluminium	Acrylic	£2,599.00
4m Octagonal	Aluminium	Acrylic	£2,519.00
4m x 3m Rectangular	Aluminium	Acrylic	£2,599.00

Accessories

	Price
Protective Cover, 900D Black	£129.00
Protective Cover, Premium Acrylic	£169.00
Stabiliser Bars	£89.00
20cm Barrel Extension	£179.00
30cm Barrel Extension	£199.00
Slimline Re-Chargeable Clip On LED Lights	£59.00

Bases

	Price
Base Plate in Black or Grey	£89.00
Stainless Steel Base Plate Upgrade	£219.00
In-Ground Base	£89.00
Large Aluminium Cross Base With Cover	£918.00
Wheeled Free-Standing Base	£779.00
Timber Decking Installation Kit	£25.00
Concrete Installation Kit	£49.00

Non-standard frames have an additional £300.00 charge and a 12-15 week lead time.





"It is easy to open, close, and put on the protective cover... Plenty of shade, and can be adjusted as the sun moves across the sky."

- Caroline B, Private Client



Nova

Centre Post Parasol

A heavy-duty commercial giant telescopic parasol that offers maximum shade protection throughout the day.

Sizes Available
 3m Square, 4m Square, 5m Octagonal, 5m Square, 3.5m x 2.3m Rectangular, 4m x 3m Rectangular, Offset 3.5 x 2.5m Rectangular

The Nova can be made to order in a wide range of premium acrylic fabrics, see page 61 for the full range.

Standard Frame



Aluminium

			
3 years FRAME WARRANTY	10 years FADE WARRANTY	100 km/h WIND RATING	801 UV STANDARD



Nova · 4m Square · Custom Brown · Printed · Aluminium

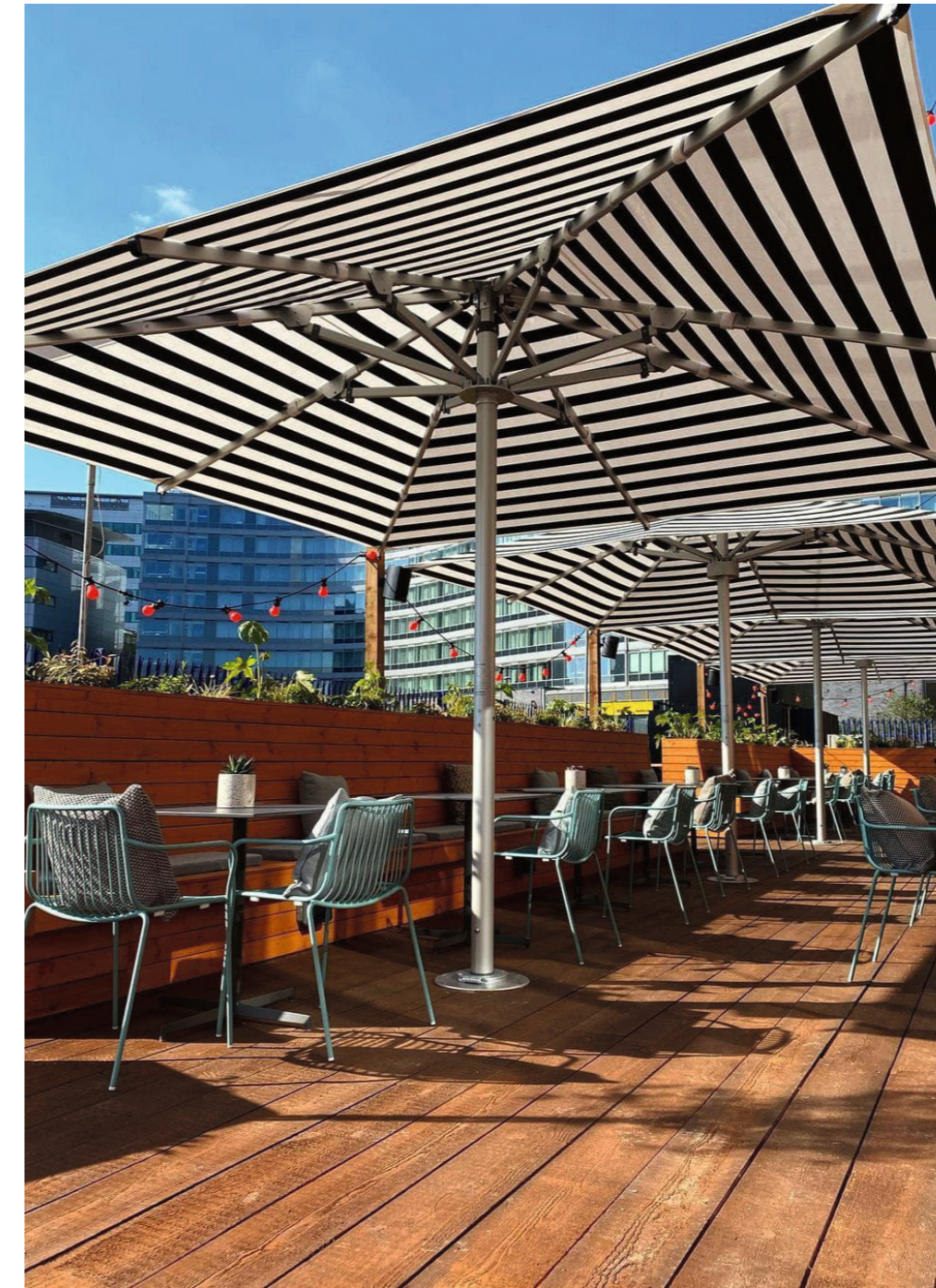

Nova - 4m Square - Black & White Stripe - Aluminium



Nova with Heat & Light Centre Post Parasol

A heavy-duty commercial giant telescopic parasol that offers maximum shade protection throughout the day.

Sizes Available

3m Square, 4m Square, 5m Octagonal, 5m Square, 3.5m x 2.3m Rectangular, 4m x 3m Rectangular, Offset 3.5 x 2.5m Rectangular

The Nova can be made to order in a wide range of premium acrylic fabrics, see page 61 for the full range.

Standard Frame



Aluminium

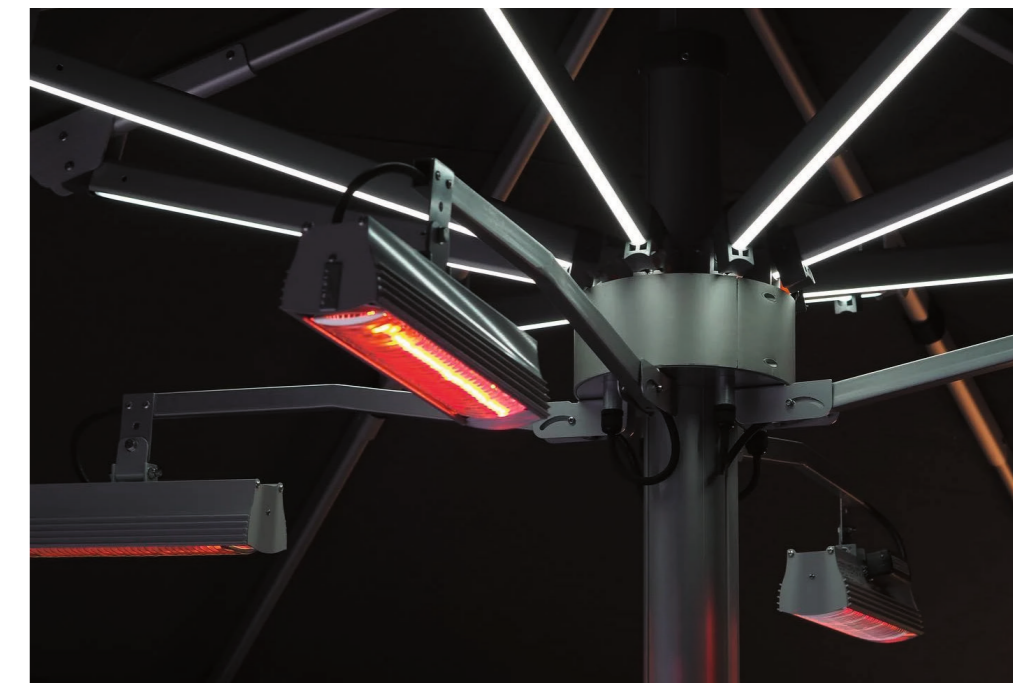

Nova with Heat & Light · 4m Square · Navy · Printed · Aluminium

Nova Centre Post Parasol

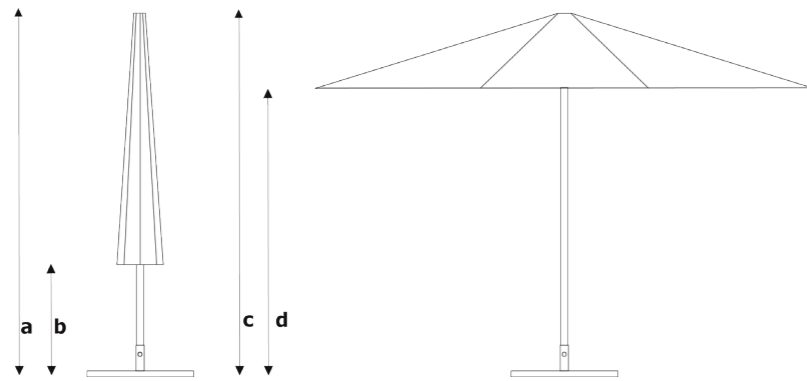

Dimensions

Measured from point to point. All measurements are rounded and are subject to change. Wind damage is not covered by the warranty.

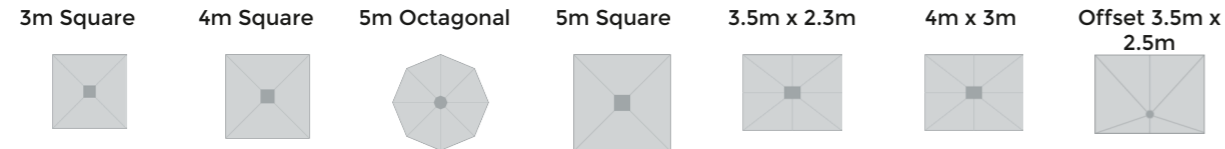

Closed Parasol	3m Square	4m Square	5m Octagonal	5m Square	3.5m x 2.3m	4m x 3m	Offset 3.5m x 2.5m
a. Height (cm)	401	418	419	446	432	432	432
b. Closed Canopy Clearance (cm)	189	133	170	92	176	183	176
Open Parasol							
c. Height (cm)	285	308	308	316	311	306	311
d. Canopy edge height (cm)	231	232	232	232	243	233	243
Parasol mast diameter (mm)	94	94	94	94	94	94	94
Canopy Shade Area	9m ²	16m ²	17.6m ²	25m ²	8.05m ²	8.75m ²	8.75m ²
Packaging Dimensions							
Dimensions of Cardboard packaging (cm)	420 x 46 x 46	460 x 46 x 46	460 x 46 x 46	460 x 46 x 46	460 x 46 x 46	460 x 46 x 46	460 x 46 x 46
Weight (Boxed Umbrella)(kg)	100	100	110	115	100	100	100
Wind Rating Guide							
Installed Wind Rating	100	90	90	80	100	90	100



Strengthened extruded aluminium mast



Telescopic crank system



Marine grade aluminium frame



Double reinforced joints

Parasol Size	Frame	Canopy	Price (£)
3m Square	Aluminium	Acrylic	£2,425.00
4m Square	Aluminium	Acrylic	£2,655.00
4m x 3m Rectangular	Aluminium	Acrylic	£2,655.00
5m Octagonal	Aluminium	Acrylic	£2,765.00
5m Square	Aluminium	Acrylic	£3,135.00
3.5m x 2.3m Rectangular	Aluminium	Acrylic	£2,309.00
Offset 3.5m x 2.5m	Aluminium	Acrylic	£2,309.00

Bases	Price
Base Plate	£149.00
In-Ground Base	£149.00
Large Aluminium Cross Base With Cover	£918.00
Seated Base Box	£1,925.00

Accessories	Price
Protective Cover	£129.00
Integrated LED Lighting	£499.00

Non-standard frames have an additional £300.00 charge and a 12-15 week lead time.



Nova · 3m Square · Natural · Aluminium



“Outdoor dining is now a permanent feature in many of our towns and cities and facilities like these support tourism businesses to provide access to outdoor dining options for longer periods of the year.”

- Eva Costello, Manager, Wild Atlantic Way at Fáiite Ireland

“Completed in only a few weeks, Tobergal Lane ‘sparks joy’ for all who pass through it. That is a wonderful accolade for any placemaking project.”

- Councillor Michael Clarke, The Cathaoirleach of Sligo County Council



Vista

Wall-mounted Parasol

Sensible and stylish, our Vista wall-mounted parasol is the ideal shade solution for small spaces.

Sizes Available
 1.9m Square, 2.3m Square, 2.7m Hexagonal, 3m Hexagonal

Standard Colours
 A large range of non-standard colours are available (see page 61) with an additional charge of £149.00 and increased production time.

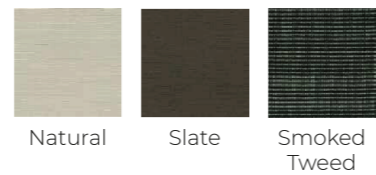



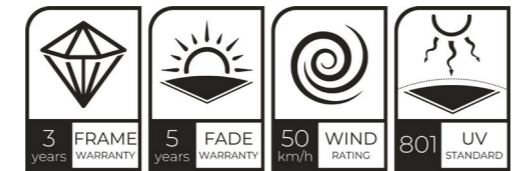
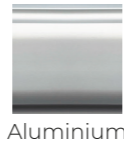

Standard Frames



Vista · 3m Hexagonal · Natural · Aluminium

Vista Wall-mounted Parasol

Dimensions	1.9m Square	2.3m Square	2.7m Hex	3m Hex
<i>Measured from point to point. All measurements are rounded and are subject to change. Wind damage is not covered by the warranty.</i>				
Open Parasol				
a. Full length with evolution arm (cm)	286	315	310	329
b. Evolution arm length (cm)	210	210	210	210
c. Width of Canopy (cm)	190	230	270	300
d. Height of canopy pole (cm)	77	77	77	77
Canopy shade area	3.6m ²	5.3m ²	4.7m ²	5.8m ²
e. Wall bracket (cm)	30h x 9w x 5d	30h x 9w x 5d	30h x 9w x 5d	30h x 9w x 5d
Packaging Dimensions				
Dimensions of cardboard packaging (cm)	145 x 41 x 21	145 x 41 x 21	145 x 41 x 21	145 x 41 x 21
Weight of boxed umbrella (kg)	11	12	13	15
Wind Rating Guide				
Install Wind Rating (km/h)	50	30	40	30

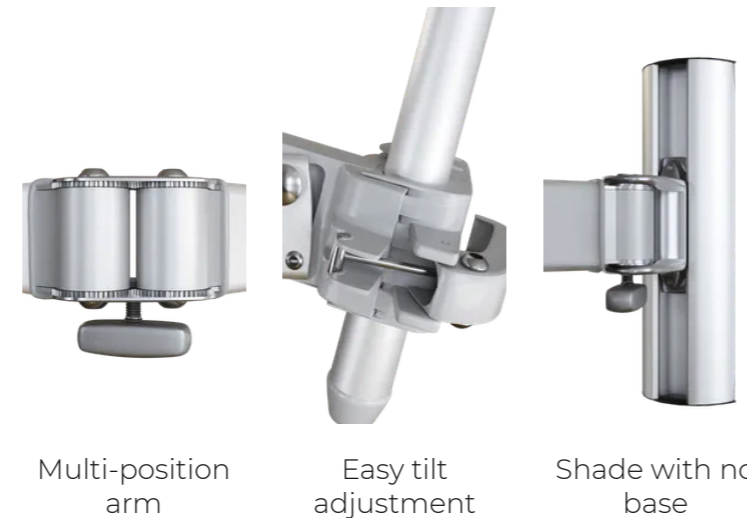
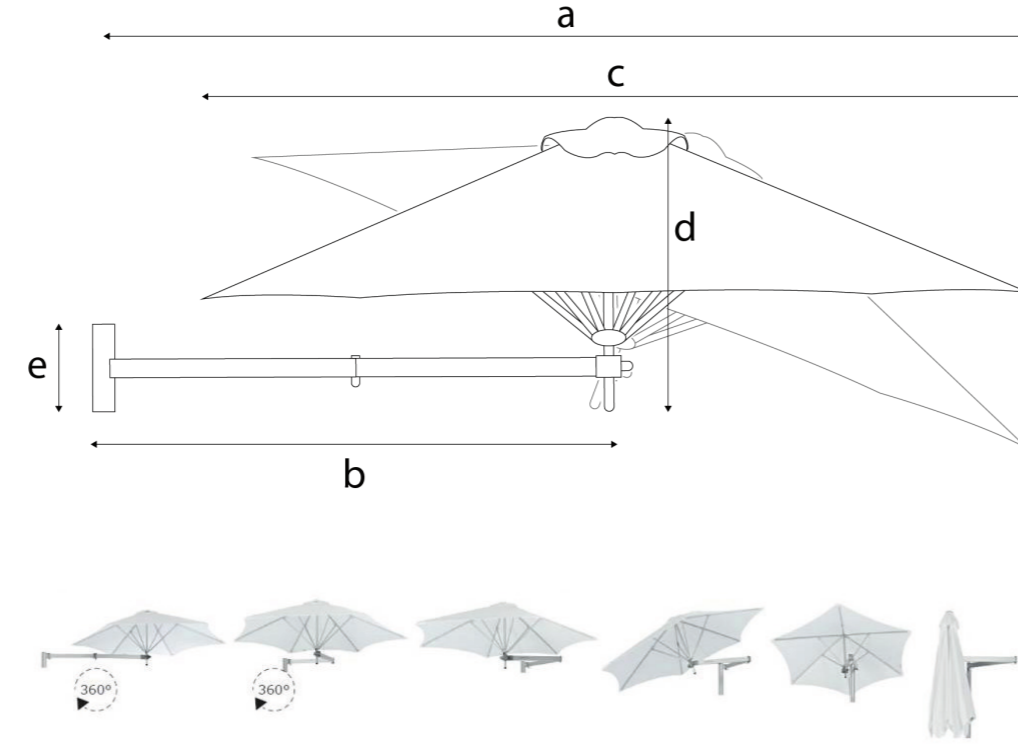

Size	Frame	Canopy	Price (£)
1.9m Square	Aluminium	Acrylic	£1,084.00
2.3m Square	Aluminium	Acrylic	£1,339.00
2.7m Hexagonal	Aluminium	Acrylic	£1,474.00
3m Hexagonal	Aluminium	Acrylic	£1,474.00

Accessories	Price
Protective Cover	£89.00
Slimline Re-Chargeable Clip On LED Lights	£59.00





NEW

Greenwich

Centre Post Parasol

The Greenwich parasol is elegant, refined and sure to satisfy your need for shade in any upscale commercial or residential setting.

Sizes Available

1.9m Square, 3.2m Octagonal, 2.5m x 3.4m Rectangular, 3m x 4m Rectangular

Standard Colours

A large range of non-standard colours are available (see page 61) with an additional charge of £149.00 and increased production time.



Standard Frame



Aluminium

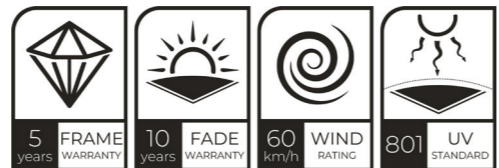

Greenwich · 1.9m Square · Black and White Stripe · Aluminium

Greenwich Centre Post Parasol

Dimensions

Measured from point to point. All measurements are rounded and are subject to change. Wind damage is not covered by the warranty.

1.9m Square



3.2m Oct



2.5m x 3.4m



3m



Frame Specifications

Post (outside diameter)(mm)	1.9m Square	3.2m Oct	2.5m x 3.4m	3m
	38	38	50	50

Closed Parasol

a. Height (cm)	259	274	292	292
b. Closed canopy clearance (cm)	106	101	70	70

Open Parasol

c. Height to edge of canopy (cm)	193	208	218	221
Canopy shade area	4m ²	7.2m ²	8.5m ²	9m ²

Packaging Dimensions

Dimensions of cardboard packaging (cm)	1.9m Square	3.2m Oct	2.5m x 3.4m	3m
	180 x 21 x 21	200 x 24 x 24	300 x 29 x 26	300 x 29 x 26
Weight of boxed parasol (kg)	10	16	23	23

Wind Rating Guide

Install Wind Rating (km/h)	60	60	50	50
Free-standing base rating (km/h)	30	30	25	25

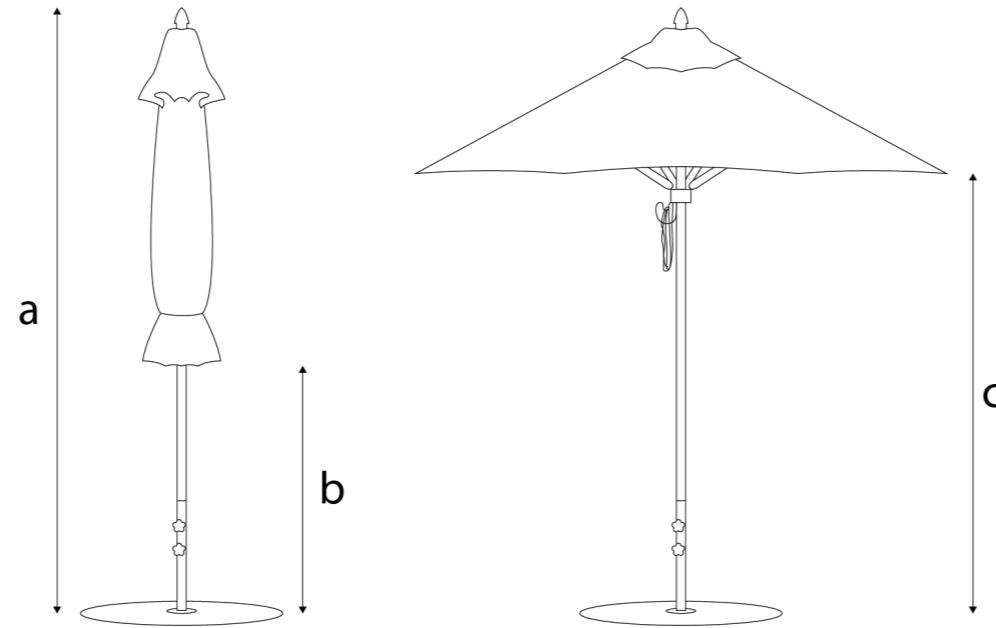

Commercial pulley system



Polished silver anodised aluminium finish



High impact polymer joints



Extruded aluminium ribs

Size	Frame	Canopy	Price (£)
1.9m Square	Aluminium	Acrylic	£429.00
3.2 Octagonal	Aluminium	Acrylic	£749.00
2.5m x 3.4m Rectangular	Aluminium	Acrylic	£569.00
3m Square	Aluminium	Acrylic	£739.00

Bases

	Price
14kg Steel Base	£109.00
19kg Steel Base	£129.00
35kg Concrete Ring Base	£129.00
45kg Concrete Ring Base	£159.00
35kg Wheeled Base	£299.00
35kg Galvanised Steel Base	£339.00
45kg Galvanised Steel Base	£409.00
In-Ground Base	£129.00
Cam Locking Base	£129.00

Accessories

	Price
Small Protective Cover	£99.00
Slimline Re-Chargeable Clip On LED Lights	£59.00
PVC Sandbags	£49.00

Non-standard Frames - £300.00 additional charge - 12-15 week lead time.





NEW

Monterey

Centre Post Parasol

The Monterey is designed to allow you to bring commercial durability home to your cherished outdoor living space.

Sizes Available
2.7m Octagonal

Standard Colours
A large range of non-standard colours are available (see page 61) with an additional charge of £149.00 and increased production time.







Natural Slate Smoked Tweed

Standard Frame



Aluminium

 3 years FRAME WARRANTY	 5 years FADE WARRANTY	 50 WIND RATING km/h	 801 UV STANDARD
---	--	---	--



Monterey - 2.7m Octagonal - Black - Aluminium

Monterey Centre Post Parasol

Dimensions

Measured from point to point.
All measurements are rounded
and are subject to change. Wind
damage is not covered by the
warranty.

2.7m Oct



Open Parasol

a. Canopy edge height (cm)	205
b. Canopy height when tilted - Lower (cm)	155
c. Height from top of base to underside of winder handle (cm)	100
d. Canopy height when tilted - Upper (cm)	260
Canopy shade area	5.2m ²

Closed Parasol

e. Height (cm)	271
f. Closed canopy clearance (cm)	125

Frame Specifications

Post (outside diameter x thickness x length (cm))	3.8 x 0.2 x 260
---	-----------------

Packaging Dimensions

Dimensions of cardboard packaging (cm)	200 x 20 x 20
Weight of boxed parasol (kg)	11

Wind Rating Guide

Install Wind Rating (km/h)	50
Free-standing 30kg concrete base rating (km/h)	30

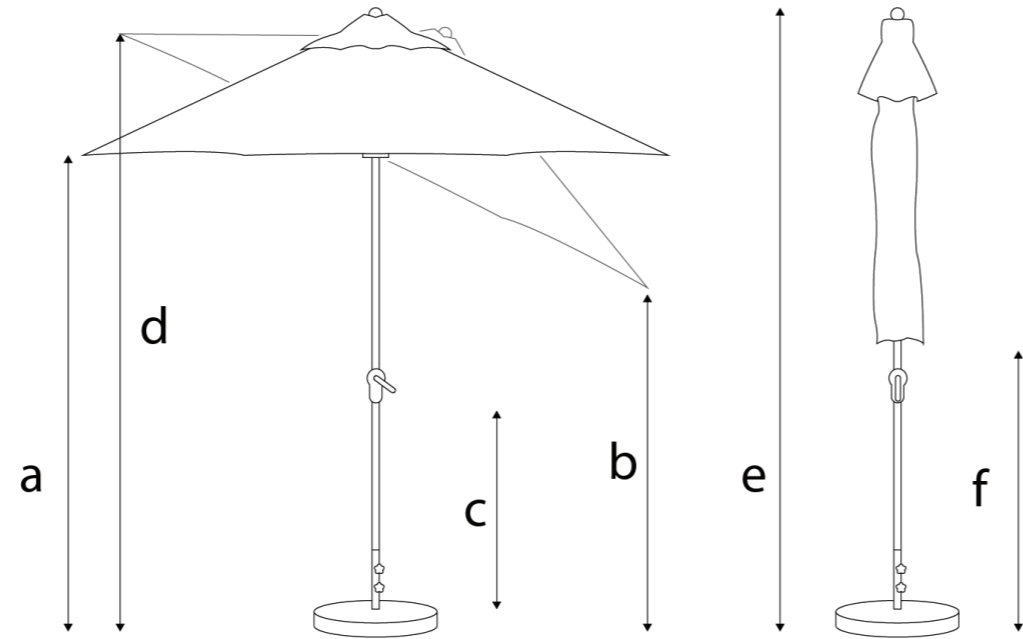

1.5" Diameter centre pole



Commercial crank auto-tilt



Strong polymer joints and fibre glass ribs

Size	Frame	Canopy	Price (£)
2.7m Octagonal	Aluminium	Acrylic	£369.00

Bases

Bases	Price
14kg Steel Base	£109.00
19kg Steel Base	£129.00
35kg Concrete Ring Base	£129.00
45kg Concrete Ring Base	£159.00
35kg Wheeled Base	£299.00
35kg Galvanised Steel Base	£339.00
45kg Galvanised Steel Base	£409.00
In-Ground Base	£129.00
Cam Locking Base	£129.00

Accessories

Accessories	Price
Protective Cover	£79.00
Slimline Re-Chargeable Clip On LED Lights	£59.00
PVC Sandbags	£49.00

Non-standard Frames - £300.00 additional charge - 12-15 week lead time.





Café Series

Centre Post Parasol

Our stylish Café Series parasol is perfect for cafés, bars and restaurants, as well as residential use, with a durable olefin canvas in several contemporary colours.

Sizes Available
 2m Square, 2.8m Octagonal, 3m Square, 4.2m Octagonal

Standard Colours
 A large range of non-standard colours are available (see page 61) with an additional charge of £149.00 and increased production time.



Black Natural Slate Smoked Tweed

Standard Frames





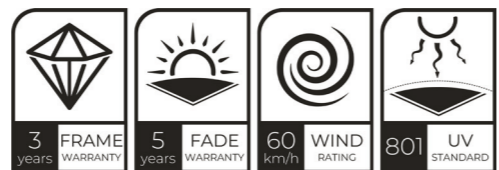

Aluminium



Café Series - 2.8m Octagonal - Black - Aluminium

Cafe Series Centre Post Parasol

Dimensions	2m Square	2.8m Oct	3m Square	4.2m Oct
<i>Measured from point to point. All measurements are rounded and are subject to change. Wind damage is not covered by the warranty.</i>				
Frame Specifications				
Post (outside diameter x thickness x length (cm))	4 x 0.2 x 260	4 x 0.2 x 260	5 x 0.2 x 290	5 x 0.2 x 290
Long arms (cm)	18 x 24 x 0.12	18 x 24 x 0.12	18 x 30 x 0.12	18 x 30 x 0.12
Closed Parasol				
a. Height (cm)	260	260	290	290
b. Closed canopy clearance (cm)	100	100	75	75
Open Parasol				
c. Height to edge of canopy (cm)	205	205	210	210
Canopy shade area	4m ²	5.5m ²	9m ²	12.4m ²
Packaging Dimensions				
Dimensions of cardboard packaging (cm)	170 x 23 x 23	170 x 23 x 23	297 x 25 x 25	297 x 25 x 25
Weight of boxed parasol (kg)	12	14	22	24
Wind Rating Guide				
Install Wind Rating (km/h)	60	60	60	60
Free-standing base rating (km/h)	30	30	30	30

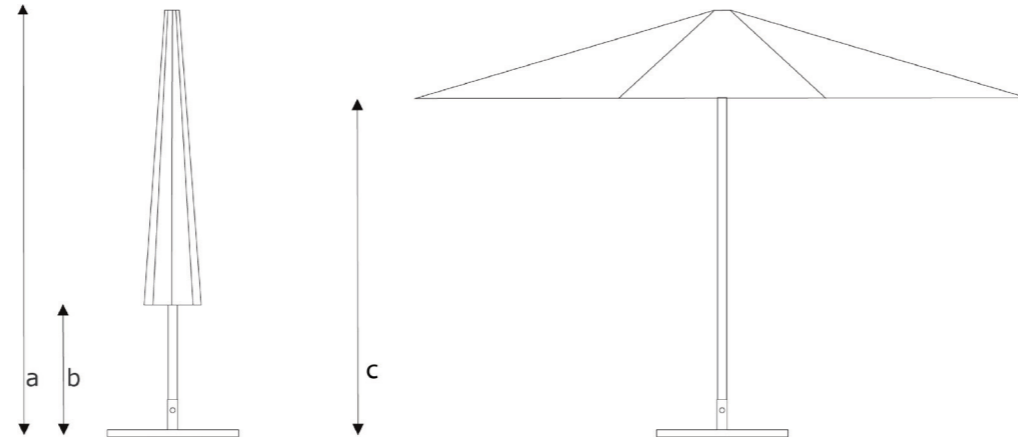

Rope and pin system



Strong nylon connectors



Silver anodised frame and arms

Size	Frame	Canopy	Price (£)
2m Square	Aluminium	Acrylic	£379.00
2m Square	Aluminium	Olefin	£289.00
2.8m Octagonal	Aluminium	Acrylic	£479.00
2.8m Octagonal	Aluminium	Olefin	£369.00
3m Square	Aluminium	Acrylic	£669.00
3m Square	Aluminium	Olefin	£509.00
4.2m Octagonal	Aluminium	Acrylic	£689.00
4.2m Octagonal	Aluminium	Olefin	£539.00

Bases	Price
14kg Steel Base	£109.00
19kg Steel Base	£129.00
35kg Concrete Ring Base	£129.00
45kg Concrete Ring Base	£159.00
35kg Wheeled Base	£299.00
35kg Galvanised Steel Base	£339.00
45kg Galvanised Steel Base	£409.00
In-Ground Base	£129.00
Cam Locking Base	£129.00
Accessories	Price
Small Protective Cover	£49.00
Large Protective Cover	£69.00
Slimline Re-Chargeable Clip On LED Lights	£59.00
PVC Sandbags	£49.00





NEW

Oakwood Premium Deckchair

With its heavy-duty solid wood construction, the Oakwood Beach Chair is designed for ultimate longevity in coastal environments.

Standard Colours
A large range of non-standard colours are available (see page 61) with an additional charge and increased production time.



Yellow and White Half Stripe Natural



Stainless steel hinges and hardware safeguard against rust.

Item	Fabric Colour	Price (£)
Deckchair	Standard Colour	£198.00
Deckchair	Non-Standard Colour	£259.00

02. Bespoke



Custom Printing

Make a lasting impression with a high-quality, custom-branded parasol. Whether for a café, restaurant, or outdoor event, our premium parasols combine durability, elegance, and full customisation to showcase your brand in the best light.

We offer dye-sublimation printing for full bespoke coverage, and heat transfer vinyl for logos and text on stock coloured fabric.

Ready to elevate your outdoor space with a custom-branded parasol? Contact us today to discuss your design and get a personalised quote.

Tel: 01925 859 960
E-mail: info@instashade.co.uk
Web: www.instashade.co.uk

01. Select Parasol

Choose the parasol you desire and contact us with your design ideas or branding requirements. We will then be able to provide a quote based on your needs and provide a design proof.

03. Approve Design

Once you are happy with your design proof, we will arrange production of your printed parasol, giving you clear timelines.

02. Send Branding

Once our team has been in touch, we will kindly ask you to send any branding and logos. Our in-house design team can create your design from scratch or simply work with your own designs.

04. Receive Parasol

Once your custom printed parasol has been printed and assembled, we will arrange for dispatch and or installation.





Vinyl Printing

This style of printing is perfect for text and logos that are isolated on a stock colour canopy. Heat transfer vinyl is expertly printed and pressed in-house at our Cheshire-based studio to ensure durability and give a quality finish that stands out. Of our three printing options, vinyl is the most budget-friendly option, as you can choose to have as few or as many of the sides of your parasol printed as you would like. It also comes with our shortest standard lead time, perfect if you're on a tight schedule.

It is important to keep in mind however that vinyl print does have limitations on the scale of your artwork, and the design cannot go all the way to the edge of the canopy.





Screen Printing

Screen print can be applied to any of our existing fabric colours and is best for imagery with up to 5 colours, however unlike vinyl the print can be applied all the way to the edge of the canopy with no limitations to size.

UV Printing

UV printing allows for full edge to edge coverage of the parasol with your artwork to create a strong impression for your brand. There are no limits to scale and colour meaning your creativity can take centre stage. Our UV printing has far higher UV properties when compared to standard dye-sublimation, meaning the print will not fade.





Valance Options

Our bespoke valance collection allows each parasol to be tailored with a distinctive, design-led finish. The range includes the elegant Belgravia, the contemporary Hove, the decorative Hampstead Fringe, and the statement Salcombe Stripe, each offering a unique aesthetic to suit both classic and modern outdoor schemes. Crafted from our premium performance fabrics, every valance is designed to enhance visual identity while maintaining exceptional durability, UV resistance and long-term colour stability. Ideal for residential, hospitality and branded environments, these bespoke details create a refined and recognisable signature.



Belgravia Valance



Hove Valance



Salcombe Stripe

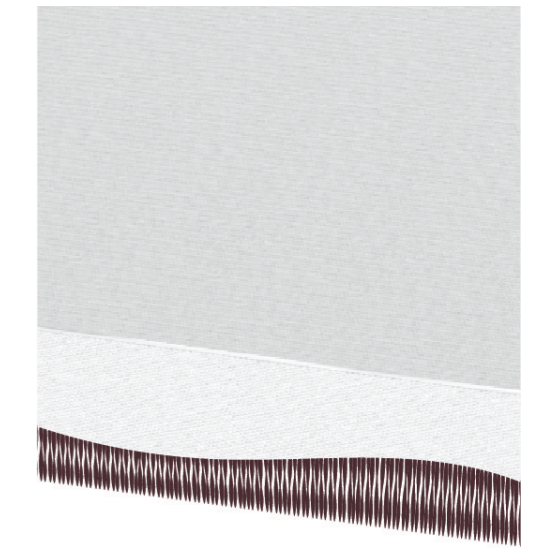

Hampstead Fringe



Trims

Our custom trim and colour options allow each parasol to be tailored with complete design flexibility, creating a truly bespoke finish. Beyond refined edge trims, we offer the ability to customise individual elements, including contrasting trims, alternating canopy panels, and accent-coloured vents, enabling striking combinations or subtle tonal detailing. Available in a curated selection of premium colours and finishes, every component can be specified to complement or enhance the main canopy fabric. Whether the goal is understated elegance or bold brand expression, we can accommodate virtually any colour configuration to achieve a cohesive and elevated aesthetic.

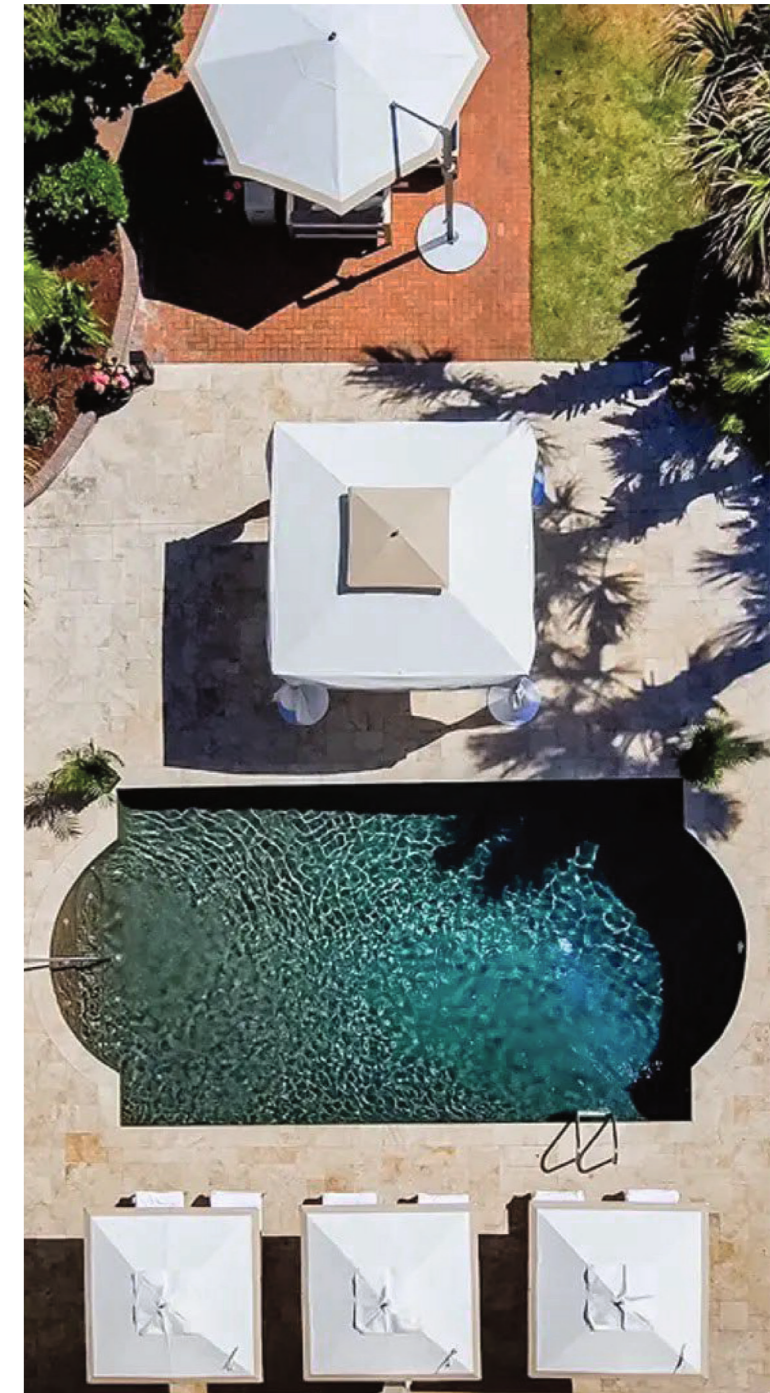

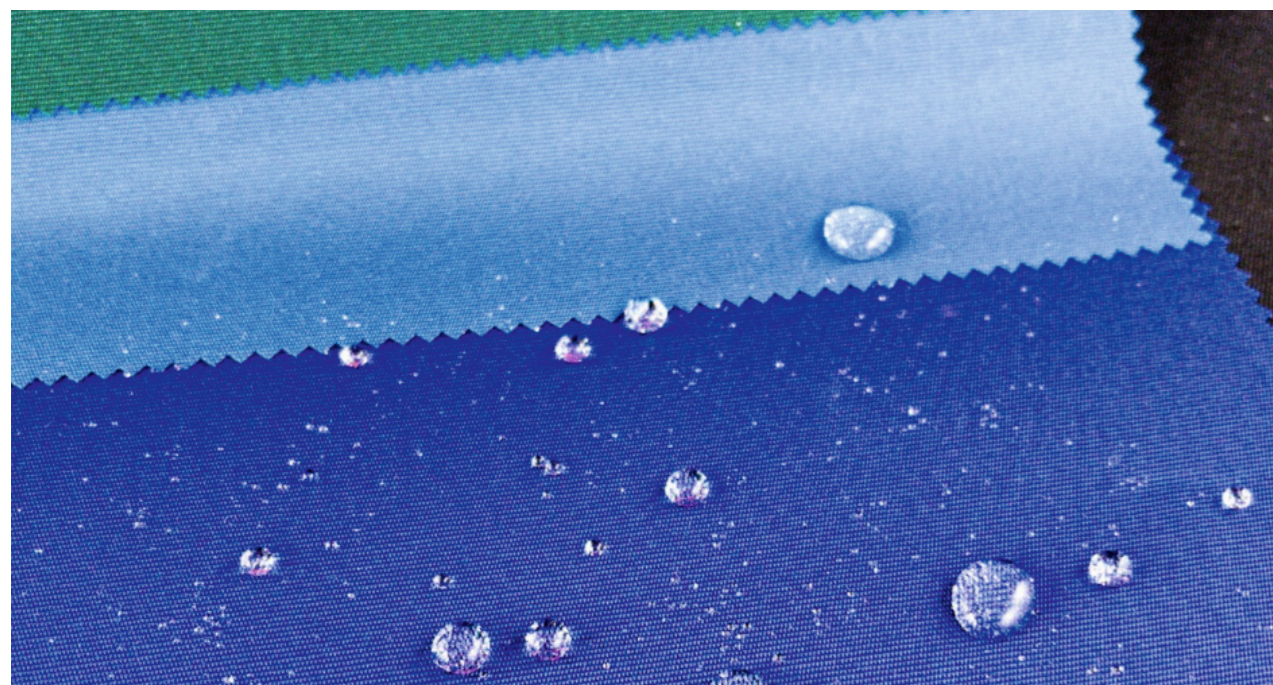

Our Fabrics

Our 100% solution-dyed acrylic fabrics originate from a liquid acrylic polymer solution. Colour pigments are then added to the polymer solution before the fibre is extruded.

During the spinning process, the liquid is transformed into yarn that is fully dyed. This means the colour does not just remain on the surface, but it is consistent right from the heart of the yarn.

This results in 100% solution dyed acrylic fabrics that have exceptional colour retention as well as excellent technical properties and UV and weather resistance.





Olefin Canvas



Smoked Tweed Slate Natural

Premium Acrylic Canvas Stripes



Red Stripe Orange Stripe Yellow Stripe



Teal Stripe Turquoise Stripe Blue Stripe



Navy Stripe Black Stripe



Premium Acrylic Canvas

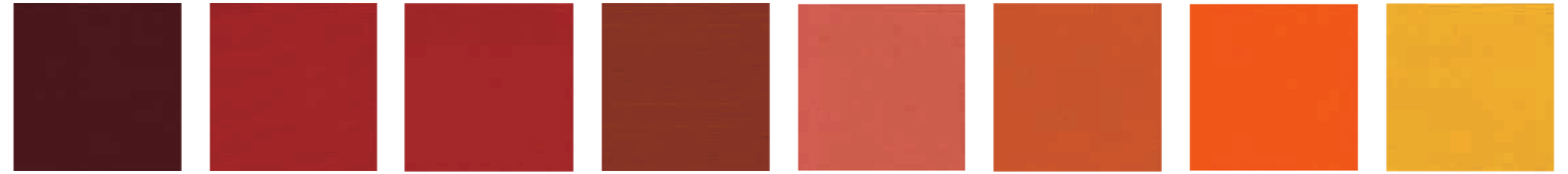

Burgundy Vermilion Red Chestnut Salmon Pumpkin Orange Yellow



Pistachio Khaki Forest Green Jade Teal Turquoise Sapphire Light Blue



Steel Blue Pacific Blue Sailors Navy Lily Black Carbon Charcoal Grey Smoked Tweed



Cadet Grey Slate Chocolate Tan Natural Pearl Linen White

*Fabric colours may vary slightly from printed swatches shown above



Frame Options

We have a stunning range of frame options to perfectly complement your chosen canopy colour or fit seamlessly with your existing garden furniture. Onyx, Carbon and Alpine White create a sleek, modern finish that works well with every colour. Wood Effect and Heather Willow have a more natural look perfect for gardens and other outdoor spaces.

Please note that not all frame finishes are available for every parasol.

Non-standard frames have an additional £300.00 charge and a 12-15 week lead time.

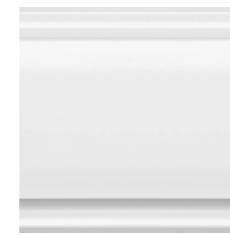

Alpine White

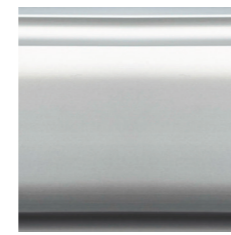

Aluminium



Carbon

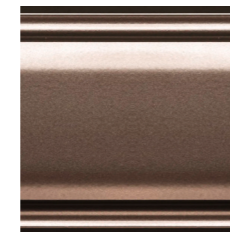

Desert Bronze



Heather Willow

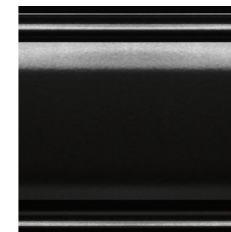

Onyx



Wood Effect



03. Bases & Installation

Free-standing Bases



Steel Base
14kg £109.00
19kg £129.00

Compatible with:
Cafe Series, Greenwich and
Monterey



Concrete Ring Base
35kg £129.00
45kg £159.00

Compatible with:
Cafe Series, Greenwich and
Monterey



35kg Wheeled Base
40mm Spigot £299.00
50mm Spigot £299.00

Compatible with:
Cafe Series, Greenwich and
Monterey

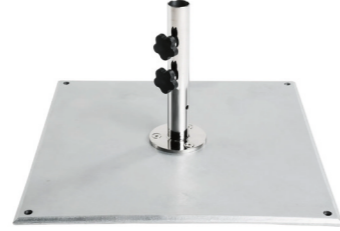

Galvanised Steel Base
35kg £339.00
45kg £409.00

Compatible with:
Cafe Series, Greenwich and
Monterey



Cross base with Pavers
£339.00

Compatible with: Aurora
Comes with 4 x 25kg concrete blocks

Installed Bases



Cafe Series, Greenwich and
Monterey In-ground Base
£129.00



Eclipse and Aurora In-
ground Base
£89.00



Nova In-ground Base
£149.00



Stainless Steel Spigot Up-
Grade
£219.00

Compatible with:
Eclipse and Aurora



Cam Locking Base
£129.00

Compatible with:
Cafe Series, Greenwich and
Monterey



Aluminium Cover for Cross
Base
£918.00

Compatible with:
Nova and Eclipse



Wheeled Free-standing
Base
£779.00

Compatible with:
Aurora and Eclipse



Seated Base Box
£1,925.00

Compatible with:
Nova

Cushion and box can be customised
to your choice of colour.



Eclipse and Aurora Base
Plate
£89.00

Available in:
Black and Grey



Stainless Steel Base Plate
Upgrade
£219.00

Compatible with:
Eclipse and Aurora



Nova Base Plate
£149.00



Concrete Installation Kit
£49.00

Compatible with:
Eclipse and Aurora



Decking Installation Kit
£25.00

Compatible with:
Eclipse and Aurora



Our Installation Service

We have a dedicated in-house installation team who travel throughout the UK and Europe to install our parasols in both domestic and commercial settings. Installation can include the fitting of the in-ground base which is perfect for paving slabs, grass or gravel and the base plates fitted into solid concrete patios or onto decking (wood or millboard).

As each of our orders are so bespoke and each location requires varying travel times and installation methods, the price for installations will be quoted at the point of order.

During our busy spring and summer season, there can be a longer waiting period for your selected installation dates. We would highly recommend booking this as much in advance as possible if you would like installation between April and August. Installation dates can only be confirmed for confirmed orders and when your deposit has been paid.

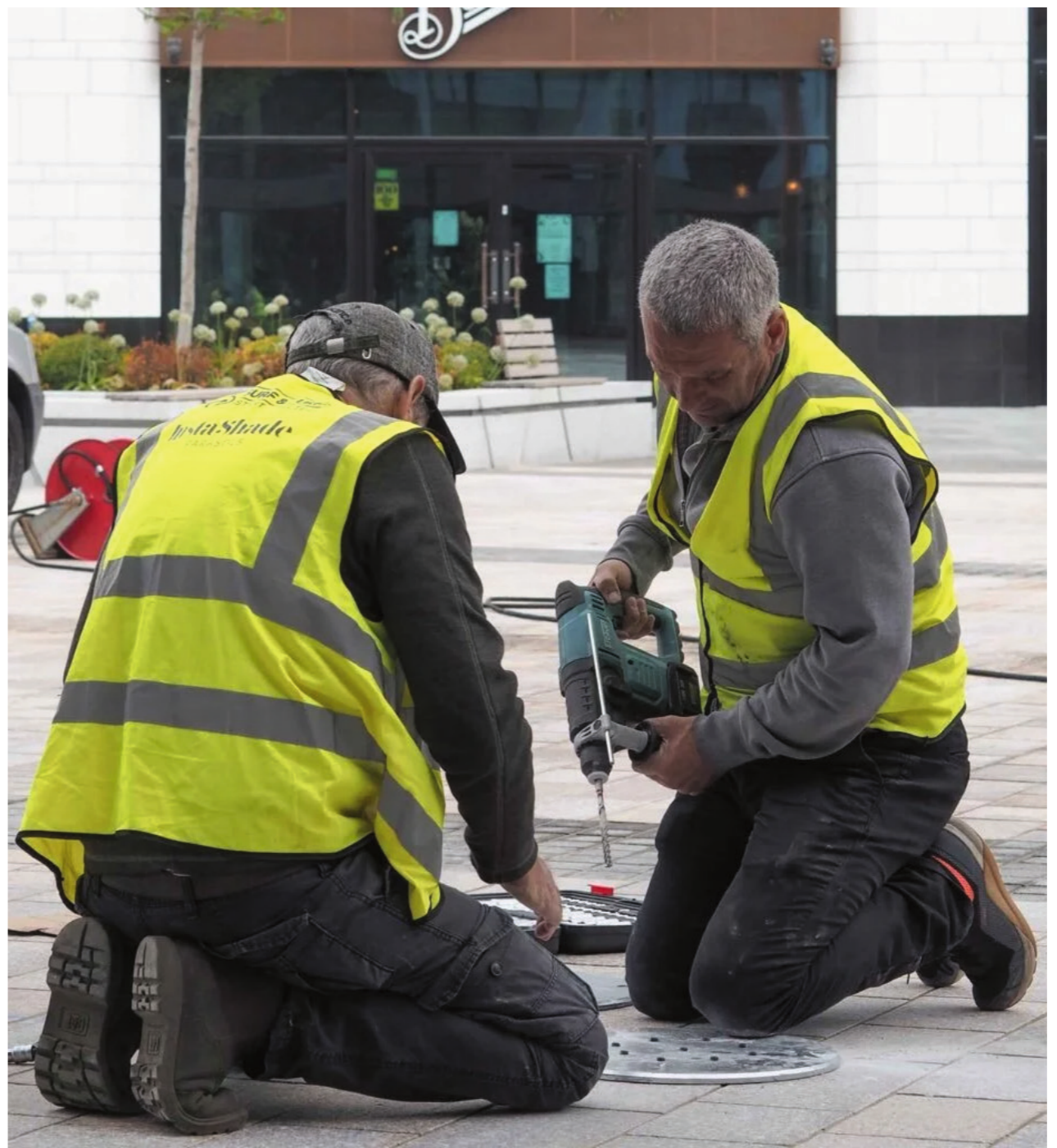

All of our luxury parasols come complete with a spigot allowing you to connect your parasol to the base beneath. Our removable and semi-permanent bases are chosen separately.

If you intend to keep your parasol in one place, we recommend the semi-permanent option for the following reasons:

- Maximum security and stability.
- Increased wind resistance.
- Umbrella can be easily removed.
- All installation options.
- No large base.

Accessories



Stabiliser Bars
Aurora £69.00
Eclipse £89.00



Slimline Re-chargeable
Clip on LED Lights
£59.00



Barrel Extension
20cm £179.00
30cm £199.00

Compatible with:
Eclipse and Aurora



Pair of PVC Sandbags
£49.00

Compatible with:
Cafe Series and Greenwich



Aurora & Eclipse Protective
Cover
900D Black £129.00
Premium Acrylic £169.00



Cafe Series Protective
Cover
Small £49.00
Large £69.00



Nova Protective Cover
£195.00



Monterey Protective Cover
£79.00



Greenwich Protective Cover
£99.00



Vista Protective Cover
900D Black £59.00
Non-Std Premium Acrylic
£89.00

InstaShade

PARASOLS

OUTDOOR SHADE EXPERTS

A family-run business rooted in
over 20 years of industry expertise

01925 859 960 | info@instashade.co.uk | www.instashade.co.uk